





Made in Mora, Sweden

Morakniv has been part of the Swedish handicraft tradition since 1891.

The knives are made at our factory in Mora, Sweden with the traditions and knowledge that we have gained over the years. Each knife is manufactured to the highest standards and will last for a lifetime. Morakniv has been granted a Royal warrant of appointment by His Majesty the King of Sweden, and is a proud purveyor to the Royal Court of Sweden.





Morakniv has been granted Royal Purveyor by His Majesty the King of Sweden. To be eligible for a royal warrant a company must supply goods or services to a member of the Royal Family. These companies may use the Greater Coat of Arms to indicate that they are holders of a royal warrant. A Morakniv is always a knife made in Sweden.



See Video on
YouTube



info@morakniv.se
morakniv.se



facebook.com/morakniv
@morakniv | #morakniv

Ecological, economic and social sustainability are guiding principles for our production. We are working to minimise our environmental impact, to make more efficient use of energy and materials and to create a good working environment. Our management system has been found to conform to the Quality Management System Standard: ISO 9001:2015 and ISO14001:2015.



Morakniv throughout history

Since the 17th century knives made in Mora have been used by people all over the world. The Morakniv knife has become one of the most famous symbols of Sweden and over the years it has evolved from a simple everyday concept to an established brand. Our knives are produced in Mora, Sweden, which gives us total control over the manufacturing process. A Morakniv is designed to stay extremely sharp. The steel of the blade is heat treated in a secret process which ensures that every knife has a blend of qualities (sharpness, strength, flexibility etc.) tailored to suit its purpose.

Contents

A part of you since 1891.....	9
Always made in Mora, Sweden.....	11
Our Lifetime Warranty	13
Steel Grade Mora	15
Our Ambassadors	16
Morakniv® Outdoor	23
Eldris	30
Garberg.....	39
Kansbol	40
Multi-Mount.....	41
Companion Spark.....	42
Companion	46
Children and Junior	50
Fishing.....	52
Bushcraft.....	54
Expert.....	58
Mushroom knives	60
Hunting and general outdoor	62
Morakniv® Craft.....	64
Basic	66
Pro Series	68
Construction knives.....	70
All-Round knives	71
Morakniv Classic.....	72
Morakniv Classic Original.....	72
Wood carving knives	76
Hook knives.....	80
Knife blade blanks	86
Morakniv® Kitchen.....	91
Classic 1891.....	95
Kitchen Accessories.....	98
Steak knives.....	101

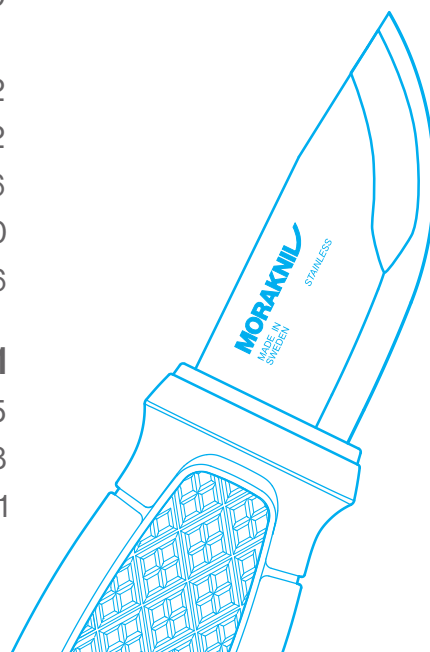

Frosts®	104
Frosts Hoof Trimming knives.....	108
Frosts Toeing knives.....	110
Chris Gregory Collection.....	112
Frosts® Professional Food Industry	114
Ergonomic-grip.....	122
G-grip	124
Unigrip.....	128
Progrip	132
P-grip	136
Poultry knives	137
Food Service.....	138
Sharpening steels	140
Knife care	143
Using the sharpening steel	145
The steel.....	146
The laboratory	152
An eco-friendly manufacturing.....	154
Awarded high quality knives	155
Contact us.....	158
Morakniv in media	159

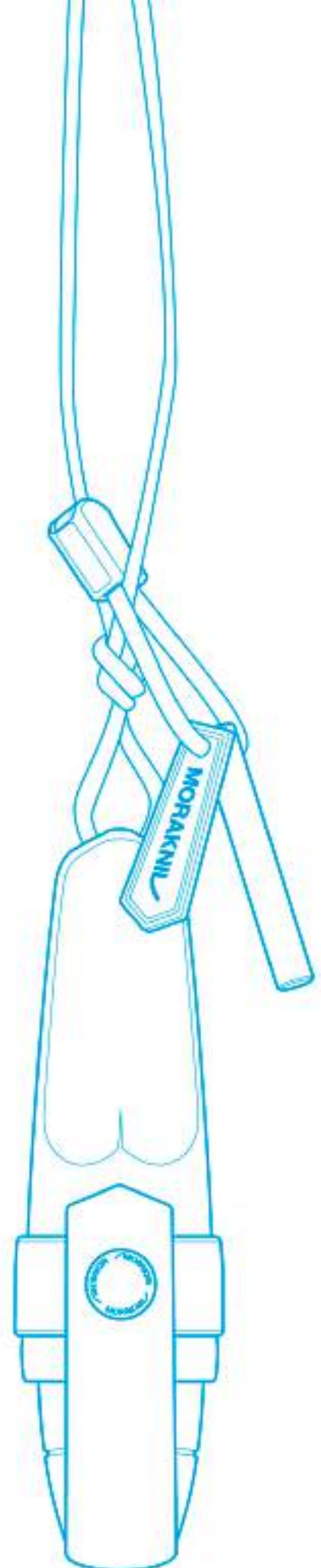



MORAKNIV
MADE IN
SWEDEN
STAINLESS

A part of you since 1891

Morakniv has been part of the Swedish handicraft tradition for more than a century. Your knife is made at our factory in Mora, Sweden with the traditions and knowledge that we have gained over the years. Each knife is manufactured to the highest standards and will last for a lifetime. It holds those cherished memories of childhood adventures and your hopes of memories still to be made. That is why Morakniv is always a part of you. Yesterday, today and tomorrow.



Always made in Mora, Sweden

Our factory is located in Mora, Sweden – just as it was a century ago. This is where we manufacture all our knives using a combination of craftsman's skills and modern technology. Design, material and methods are all constantly refined by staff who have inherited generations of professional knowledge.

Morakniv has always been a universal tool with unique properties. The durable steel is hardened in Mora using a secret recipe. The knife edge has a grind that ensures it to remain extremely sharp under frequent use over a long period of time. The tapered profile, ergonomic handle, balance and feel, power and precision are qualities that make the knife a natural companion wherever you go.



Our Lifetime Warranty

Your Morakniv is made to last

A knife from Morakniv is a robust tool that is meant to last. Morakniv guarantees that our knives are free from material, construction, or workmanship defects for the life of the product, and will last under normal use by following the care instructions. If the knife is defective due to materials, construction or workmanship, we will repair it at no cost or replace it with a new knife of the same or an equivalent model.*

Morakniv is proud and well known for our high quality. Our customers shall feel confident in buying a Morakniv and that it will last for a long time under tough conditions.

*Read more about the terms of the warranty at www.morakniv.se



MORAKNIV
MADE IN
SWEDEN
CARBON

MORAKNIV
MADE IN
SWEDEN
CARBON

MORAKNIV
MADE IN
SWEDEN
CARBON

MORAKNIV
MADE IN
SWEDEN
CARBON

MORAKNIV
MADE IN
SWEDEN
CARBON

Steel Grade Mora

SGM®

All our knives are produced in our own factory in Mora, Sweden according to our SGM® (Steel Grade Mora) standard.

The Morakniv way of treating the steel is based on well-proven and unique expertise we possess in materials technology and the insight into knife usage and applications.

This combination has led to the capability to give our knives the steel's unique qualities – such as sharpness, strength and flexibility. We call it Steel Grade Mora/SGM®.

As a world-leading developer and manufacturer of fixed blade knives our competencies include for example:

- Metallurgy and steel material characterization
- Hardening and grinding
- Process and quality control
- Corrosion-resistance

Having the right combination of academic qualifications and hands-on experience, we work closely with our customers to jointly discover ways of addressing their challenges in the development and manufacture of materials for demanding environments.

Our Ambassadors

Together we go further

We work with a number of well-known outdoor recreation personalities, for example the survival expert Johan Skullman in Sweden, and the bushcraft expert Dave Canterbury in the USA. For our kitchen range we have been collaborating with the famous chef Johan Jureskog for many years. When it comes to handicraft and wood carving, the experts Jögge Sundqvist and Beth Moen give us invaluable input on our handicraft knives. For our hoof product line, the recognized farrier Chris Gregory offers valuable feedback.

It is important that our partners and ambassadors share our values and are passionate about creating products that live up to the high demands that the user places on their knife.





Jögge Sundqvist, Sweden
Wood carving



Dave Canterbury

Dave Canterbury has more than 20 years of experience of bushcraft and survival skills. He's the founder of the popular Pathfinder School where he holds courses teaching basic skills that are invaluable if you suddenly find yourself alone in nature. His books have been on the New York Times best-seller lists and he's had his own TV series on the Discovery Channel. There's no doubt that Dave knows how to survive in the wilderness.

With Dave's massive knowledge and long experience in bushcraft and survival skills, he knows what a really good knife should be.

"You can end up in an emergency situation where your knife is your only lifeline, and that's when you want it to be a full tang. You can use it to work safely on larger masses of wood, which can save your life in the long run. The full tang can end up being your only life saver available," says Dave.



Shuhei Nagano

As well as being a Morakniv ambassador in Japan and Taiwan, Shuhei is a nature craft writer and outdoor chef. As an eminent craftsman who enjoys making his own appliances as well as cooking over open fire, Shuhei holds a lot of workshops and is featured in numerous magazines. After living in an old house in Hachioji, Tokyo, he now runs an atelier called "Nature Works" in his self-built "Minomushi (Bagworm) House" on the banks of the Doshigawa River in rural Kanagawa. Shuhei is very passionate about sharing the joys of craft.



Kieran Creevy

Kieran Creevy is an expedition and performance chef and international mountain leader with 25 years experience leading and cooking on the mountains around the world. He has produced six course tasting menus with paired wines at a mountain basecamp, served homemade pumpkin gnocchi with wild boar ragù at an overnight tent in the Italian Alps and cooked smoked reindeer loin with pine needle syrup, wild mushrooms and goat's curd for clients on Arctic ski tours.



Brandon Chee

Brandon Chee's interest for Wilderness Medicine began in 2005 and currently he is one of the instructors at Wilderness Medical Associate International (www.wildmed.com). He is certified as a Wilderness Emergency Medical Technician (WEMT). He also gained an interest in Bushcraft Survival and Boy Scouts programme. Brandon, with his 25 years of experience in the outdoor education field, has also garnered experience in conducting The Duke of Edinburgh's International Award programme throughout the Asia Pacific region. Besides that, he is also involved with International Disaster Relief Mission and Local Search & Rescue Mission. He also has a strong interest in the environment and still continues doing research in recreational ecology for his PhD. He is also a local Ambassador for Morakniv in Malaysia.



Amy Umbel, USA
Wood carving



Göhkan Konas, Turkey
Outdoor



Barnaby Carder
UK, Wood carving



Beth Moen, Sweden
Wood carving



Hyungjun Yong
Korea, Wood carving



Chris Gregory,
USA
Hoof Care



Michere Lupoli
Italy, Outdoor



Jeff Donne, Australia
Wood carving



Trenton Stander
South Africa, Outdoor



Elle Nikishkova
Sweden, Outdoor



Sophie Sellu, UK
Wood carving



Gordon Dedman
Australia, Outdoor



Jonas Als, Denmark
Wood carving



Johan Skullman, Sweden
Outdoor



Jarrod Dahl, USA
Wood carving



Morakniv® Outdoor

A part of your adventure

Sometimes we need a break from hectic daily life and what we love about nature is its ability to keep us firmly in the here and now. And of course, nature brings out our seemingly innate ability to make the smallest event into a big adventure. It doesn't matter to us when, where and how your special adventure happens, but we long to be with you and discover the possibilities around you. When the weekend gets that extra special touch as you sit by the campfire, with your own-carved sausage-stick in hand. When the morning mist has hardly lifted and the air trembles with excitement and expectation, right before the moose steps out of the forest. When the raindrops patter against the tent and your cold, damp toes slowly but surely start to thaw in your sleeping bag.

Whether you are off to the forest, mountains, lake or local park, the most important part is the experience. With a Morakniv knife in your bag you always have a trusty companion nearby. Whether you need to open a pack of sausages, make a fire, split some wood or help build a wind shelter, we are pleased to be at your service. Because we love adventures – and we would love to join you on yours.







What is your sparkling adventure?
#companionspark



The names that tell our story

Many small cottages and barns. The cattle graze on the plot outside and every morning starts before sunrise with milking the cows or goats. This was the scenery of the Swedish 'fäbod', a place where people historically spent their summers to work and let their cattle run free in the surrounding nature. It was also an important time for preparation of homemade butter and cheese for the winter.

In older days, the land closest to the village was used for cultivation during the summer and therefore people had to move the cattle away. Every village had their own 'fäbod', many times even two or more. This way, our ancestors could walk with their cattle from one settlement to another during the summer.

In the region around Mora there have always been many 'fäboddar' and many of them still exist today. The houses are mainly used as holiday cottages, where the descendants of the original farmers can escape the urban society and experience the genuine peace of nature.

Since traditions here in Mora are strong, still today, local farmers take their cattle out into the woods for a summer at the 'fäbod'.

Three of these places are called Eldris, Kansbol and Garberg - just like our newest knives. This is our way of paying tribute to our roots. To name our knives after the places and the people is a way of making our ancestors and the surroundings of Mora part of who we at Morakniv are today. It becomes our interpretation of the life once lived at the 'fäbod' of Eldris, Kansbol and Garberg.



New parts of your adventure

Remember the childhood days. The moments in the woods when adventure always was close by. The times by the lake, where hours and hours were spent waiting for the fish to strike. The sparkling fire while relaxing after a day outside in the snow. These are all warm sparks of history that inspire you to go outside in search of your next little big adventure.

No matter the size of your very own adventure, a reliable partner is always needed. In any of our knife models you can find just that. We have a knife for starting that fire, for cutting that fishing line or for batoning that log. With a Morakniv in your backpack, around your neck or on your hip you're more than ready to catch those memorable moments.

In our three outdoor news - Eldris, Kansbol and Garberg - you can find a knife for every occasion. No matter if you are the hardcore survivor, the discovering nature lover or the urban outdoor enjoyer, we have a knife for you. Because a Morakniv is more than just a knife, it's a part of you and your adventure.



Morakniv Eldris Green

Blade material:	Stainless steel
Blade thickness:	2,0 mm
Blade length:	59 mm
Knife length:	143 mm
Total length (sheath included):	152 mm
Item no. 1 pcs box/5 ctn:	12651
Item no. 1 pcs box/15 ctn:	13514
Item no. 1 pcs-PinPac/5 ctn:	12867

Morakniv Eldris Green with Fire Kit

Item no. 1 pcs box/5 ctn:	12633
Item no. 1 pcs box/15 ctn:	13521
Item no. 1 pcs-PinPac/5 ctn:	12862



Morakniv Eldris Yellow

Blade material:	Stainless steel
Blade thickness:	2,0 mm
Blade length:	59 mm
Knife length:	143 mm
Total length (sheath included):	152 mm
Item no. 1 pcs box/5 ctn:	12650
Item no. 1 pcs box/15 ctn:	13516
Item no. 1 pcs-PinPac/5 ctn:	12868

Morakniv Eldris Yellow with Fire Kit

Item no. 1 pcs box/5 ctn:	12632
Item no. 1 pcs box/15 ctn:	13523
Item no. 1 pcs-PinPac/5 ctn:	12863



Morakniv Eldris Burnt Orange

Blade material:	Stainless steel
Blade thickness:	2,0 mm
Blade length:	59 mm
Knife length:	143 mm
Total length (sheath included):	152 mm
Item no. 1 pcs box/5 ctn:	13501
Item no. 1 pcs box/15 ctn:	13519
Item no. 1 pcs blister/5 ctn:	13499



Eldris

Morakniv Eldris is an amazingly versatile, pocket-sized, fixed-blade knife. At our factory in Mora, Sweden, the precision blade is heat treated to the highest quality. The spine of the Swedish stainless steel blade is ground to a 90° angle and can thus be used with a fire starter. Compact design and all-round convenience make you want to take this knife with you on every outdoor adventure. You can also take your Eldris to the next level with the flexible fire kit. This contains a small fire starter, a secondary locking strap and, stretching the versatility even further, a multi-purpose paracord. Choose your favorite color!



Morakniv Eldris Blue

Blade material:	Stainless steel
Blade thickness:	2,0 mm
Blade length:	59 mm
Knife length:	143 mm
Total length (sheath included):	152 mm
Item no. 1 pcs box/5 ctn:	12649
Item no. 1 pcs box/15 ctn:	13515
Item no. 1 pcs-PinPac/5 ctn:	12866



Morakniv Eldris Black

Blade material:	Stainless steel
Blade thickness:	2,0 mm
Blade length:	59 mm
Knife length:	143 mm
Total length (sheath included):	152 mm
Item no. 1 pcs box/5 ctn:	12647
Item no. 1 pcs box/15 ctn:	13518
Item no. 1 pcs-PinPac/5 ctn:	12870



Morakniv Eldris Red

Blade material:	Stainless steel
Blade thickness:	2,0 mm
Blade length:	59 mm
Knife length:	143 mm
Total length (sheath included):	152 mm
Item no. 1 pcs box/5 ctn:	12648
Item no. 1 pcs box/15 ctn:	13517
Item no. 1 pcs-PinPac/5 ctn:	12869

Morakniv Eldris Blue with Fire Kit

Item no. 1 pcs box/5 ctn:	12631
Item no. 1 pcs box/15 ctn:	13522
Item no. 1 pcs-PinPac/5 ctn:	12551

Morakniv Eldris Black with Fire Kit

Item no. 1 pcs box/5 ctn:	12629
Item no. 1 pcs box/15 ctn:	13525
Item no. 1 pcs-PinPac/5 ctn:	12865

Morakniv Eldris Red with Fire Kit

Item no. 1 pcs box/5 ctn:	12630
Item no. 1 pcs box/15 ctn:	13524
Item no. 1 pcs-PinPac/5 ctn:	12864



Morakniv Eldris: Color Mix

Blade material:	Stainless steel
Blade thickness:	2,0 mm
Blade length:	59 mm
Knife length:	143 mm
Total length (sheath included):	152 mm
Item no. 1 pcs box/15 ctn:	13527
Item no. 1 pcs box/5 ctn:	12770



Morakniv Eldris Kit

Item No. 1 pcs box/5 ctn:	12888
---------------------------	-------



Morakniv Belt Loop for Eldris

Item no. 1 pcs box/10 ctn:	13273
----------------------------	-------



1 pcs box/15 ctn



See Video on YouTube

Coil shape

The coil shape in the heart of the knife is strongly related to the heritage of Morakniv. The knife with the red coil shaped handle is probably as well known as the famous Dala horse in Sweden.

Hole

The rear part of the handle has a hole for fastening a lanyard, rope or other gadgets according to preference.

Pattern

The rhombus pattern is a traditional pattern that is present in many variations in Mora and the region of Dalarna. In the handle, the pattern provides a significantly improved grip. Beside its high functionality, it also pays a tribute to our region and history.

Click lock

The handle has a built-in click lock between the sheath and handle to ensure that the knife stays in place when worn around the neck.

Rugged core

The core of the handle, visible in the barrel shape, is made of polypropylene. It is a polymer that makes the knife and the handle very rugged.

Steel

The blade is 2 mm thick and 59 mm long (or in this case short). It is made of high-quality Swedish stainless steel (12C27) that is treated to the highest quality in our own factory.

Scandi grind

The knife is grinded with a scandi grind which makes it easy to keep sharp.

Landscape weapon

The two crossed arrows with the crown is the county crest of the Swedish province Dalarna. We have placed the Morakniv edition of the crest on the sheath. We have added our founding year 1891, and the result is a tribute to the region as well as to our heritage.

Protective polymer

The sheath is made of polypropylene, a polymer that makes it rugged, and thereby provides an excellent protection for the knife.

Sheath shape

The sheath is strongly inspired by sheaths first made in the beginning of the 1900's. Sheaths that today can be found on the classic line of knives, and with a design that looks almost the same as they did back then. The heart shaped cavities on the sheath, the symmetrical appearance and the triangle shaped tip is a trademark of a classic Morakniv sheath.

Handle shape

The symmetrical handle allows flexible use of the knife with a two-way fit in the sheath. The drop design on the back is big enough to keep the knife steady in your hand.

Secure grip

The outer shell is made of TPE, a rubbery polymer that provides a firm and secure grip.

Blade finish

The blade has a semi-matte finish appreciated among the outdoor community.

Ground spine

The spine of the blade is ground to make the edge perfect for use with a fire starter. This means that you do not need to use the edge of the blade when starting your fire, which makes your knife stay sharp for longer.

Profile grind

The profile grind adds that extra touch to the blade. That is a very appreciated detail of Morakniv, that first appeared on our knives in the early 90's. The profile grind makes the knife perfect for tasks that require precision.

Symmetrical

As with the knife, the symmetry of the sheath is of big importance, since it allows you to place the knife in the sheath from both sides.

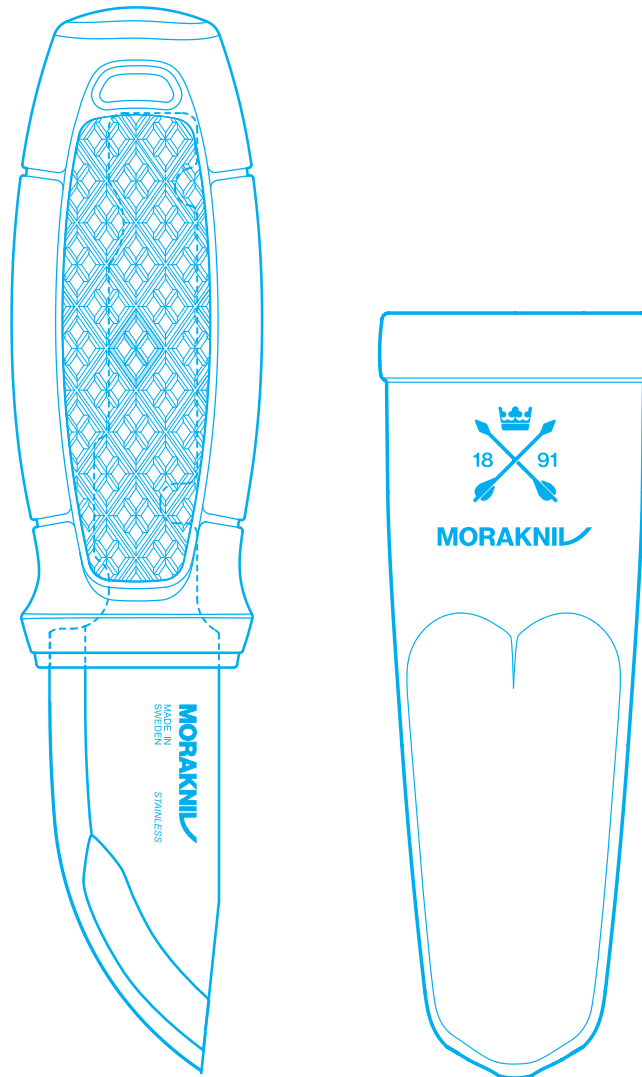





Paracord

The special thing with the paracord is that it is made of an outer sleeve and several thinner cords, which increases the possible ways of using it. A paracord is a given part of any outdoor activity, and should be brought whenever you are spending time outdoors. There are many situations this piece of string will be invaluable. Everything from making a drying line for wet clothes, to tying a broken snowmobile sledge to a snowmobile or even as an extra hand when you are gutting a moose.

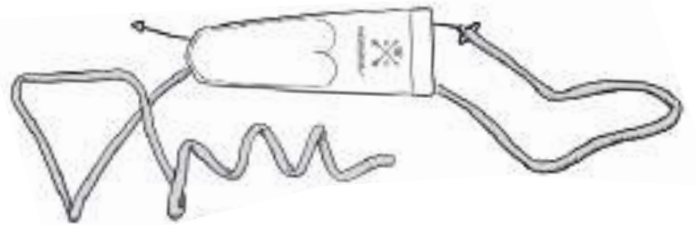

Slip knot

The knife kit includes a 1 m long paracord string that enables you to make a lanyard. Use the slip knot, it is a stopper knot which is easily undone by pulling the tail (working end). It will be released in case you get stuck.

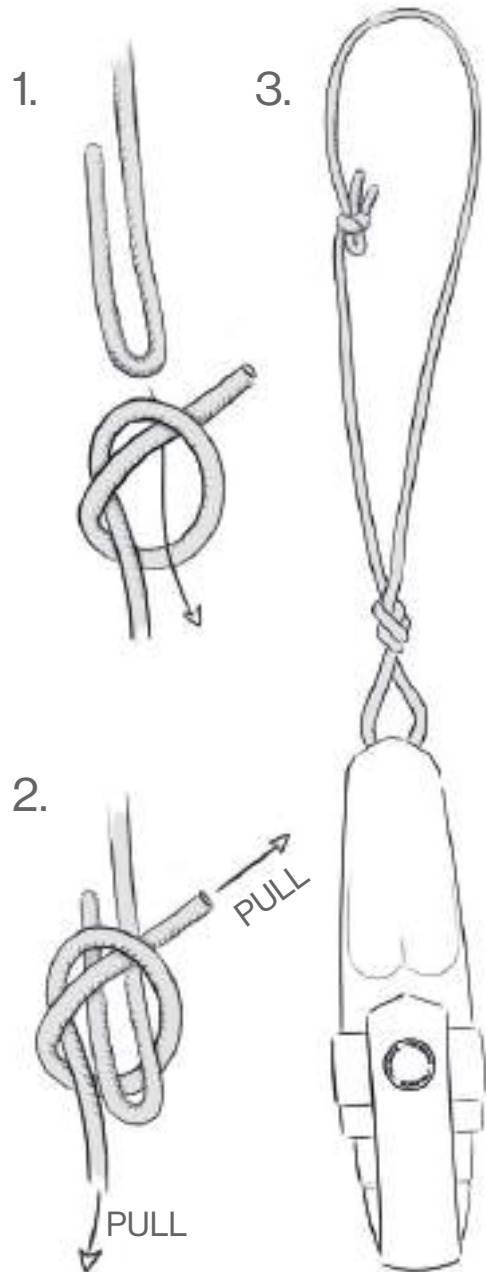

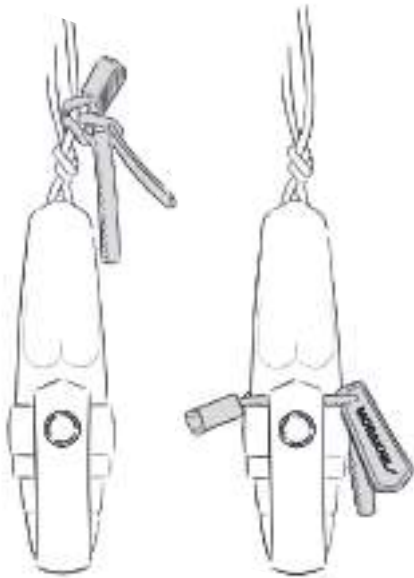

Fire starter of matching size

The fire starter has a minimalist design to fit with the pocket sized knife. Attach the firestarter to the knife with the paracord. It is optimal for starting your fire or igniting a camping stove.

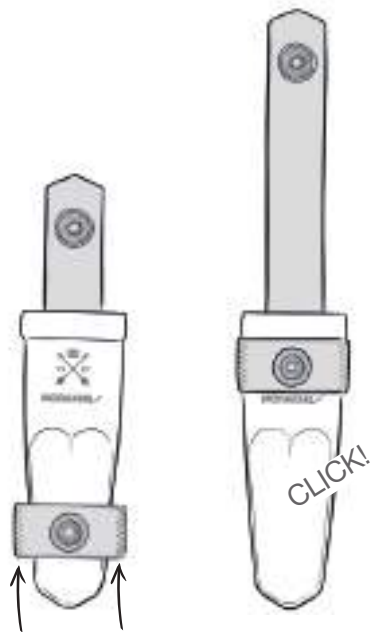
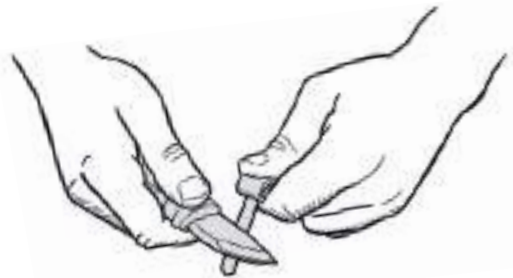
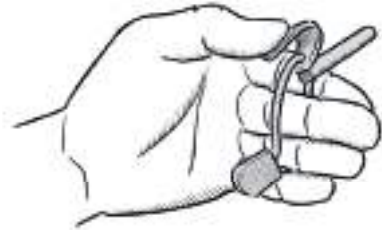
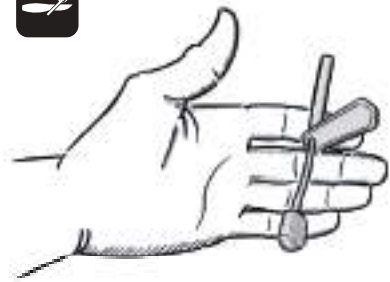

Secondary locking

When on the paracord, the secondary locking strap prevents the knife from falling out of the sheath. That way you can feel confident that the knife is always safe in place.

The lock consists of a strap attached to a collar. It can be taken on and off, since it is possible to slide the collar onto the sheath and snap it into place.

⚠ Always use the back of the knife when using the fire starter





What adventure are you looking for?
#eldris



MORAKNIV
3 STAMPLES
MADE IN SWEDEN

18 01

MORAKNIV



MORAKNIV

Garberg

Morakniv Garberg is a strong full-tang knife designed to meet the toughest challenges. It is the most robust knife we have ever made. The revolutionary handle material is nearly unbreakable. The 3,2 mm thick blade is made from high-quality Swedish stainless steel or coated carbon steel.



Morakniv Garberg S with Polymer Sheath

Blade material:	Stainless steel
Blade thickness:	3,2 mm
Blade length:	109 mm
Knife length:	229 mm
Total length (sheath included):	242 mm
Item no. 1 pcs box/5 ctn:	13715



Morakniv Garberg S Multi-Mount

Blade material:	Stainless steel
Blade thickness:	3,2 mm
Blade length:	109 mm
Knife length:	229 mm
Total length (sheath included):	245 mm
Item no. 1 pcs box/5 ctn:	12642



Morakniv Garberg S Leather Sheath

Blade material:	Stainless steel
Blade thickness:	3,2 mm
Blade length:	109 mm
Knife length:	229 mm
Total length (sheath included):	248 mm
Item no. 1 pcs box/5 ctn:	12635



Morakniv Garberg Black C - Multi-Mount

Blade material:	Carbon steel
Blade thickness:	3,2 mm
Blade length:	109 mm
Knife length:	229 mm
Total length (sheath included):	245 mm
Item no. 1 pcs box/5 ctn:	13147



Morakniv Garberg Black C with Polymer Sheath

Blade material:	Carbon steel
Blade thickness:	3,2 mm
Blade length:	109 mm
Knife length:	229 mm
Total length (sheath included):	242 mm
Item no. 1 pcs box/5 ctn:	13716



Morakniv Garberg Black C - Leather Sheath

Item no. 1 pcs box/5 ctn:	13100
---------------------------	-------



See Video on YouTube



Multi-Mount Kit for Garberg

Item no. 1 pcs box/5 ctn:	13000
---------------------------	-------



Leather Sheath for Garberg

The sheath is made from 3 mm thick premium high quality black leather. It has a sturdy and generous cover that is easy to open and makes sure the knife stays securely in place. The back of the sheath has a belt loop from the same high-quality leather. This natural material is something that will look and feel better the more you use it. It simply gets better with time and is something you can enjoy for the rest of your life.

Item no. 1 pcs box/5 ctn:	13272
---------------------------	-------

Let your creative juices flow

Only your imagination can limit your possibilities with our Multi-Mount. The range of mounting options is endless, thanks to its hook and loop strap, various straps, holes, and notches. And of course, it is MOLLE compatible.

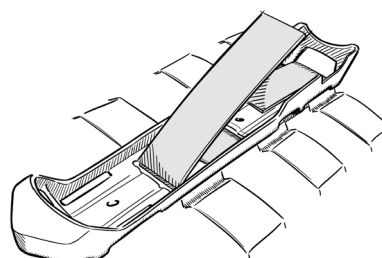
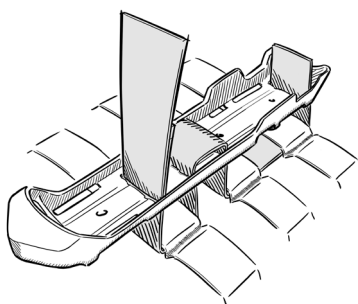
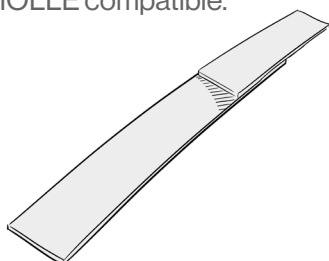

Kansbol

Morakniv Kansbol is the ultimate all-round knife. Out in the woods, on the water, hiking or hunting, it is the perfect partner. At our factory in Mora, Sweden, the steel is specially SGM® (Steel Grade Mora) heat treated to enhance its strength and long-lasting sharpness. The blade has a profile grind for added precision and the spine is ground to a 90° sharp angle so that it can be used with a fire starter. With its firm, secure grip and superb feel, you will never want to be without your Morakniv. It will be a part of you!



Morakniv Kansbol Green

The sheath is made of polypropylene, a polymer that makes it rugged, and thereby provides an excellent protection of the knife. Both the handle and the sheath are symmetrical, which enables both left and right hand use. It also allows you to place the knife in the sheath from both sides.

Blade material:	Stainless steel
Blade thickness:	2,5 mm
Blade length:	109 mm
Knife length:	226 mm
Total length (sheath included):	250 mm
Item no. 1 pcs box/5 ctn:	12634
Item no. 1 pcs-PinPac 5/ctn:	12872



Morakniv Kansbol Green Multi-Mount

The Morakniv Multi-Mount is a versatile mounting solution that takes your knife use to the next level. It allows the knife to be mounted virtually anywhere you want. It is compatible with the MOLLE standard mounting system. It has strategically placed screw holes and slots for different types of straps. The knife is kept safe in the mount with a hook and loop strap. It allows a secure mounting as well as a fast and easy attachment.

Blade material:	Stainless steel
Blade thickness:	2,5 mm
Blade length:	109 mm
Knife length:	226 mm
Total length (sheath included):	250 mm
Item no. 1 pcs box/5 ctn:	12645



Multi-Mount Kit for Kansbol

A Multi-Mount kit for Kansbol. Includes three Velcro-straps, a loop collar and a secondary locking collar.

Item no. 1 pcs box/5 ctn: 13002



Morakniv Kansbol Burnt Orange

The sheath is made of polypropylene, a polymer that makes it rugged, and thereby provides an excellent protection for the knife. Both the handle and the sheath are symmetrical, which enables both left and right hand use. The color is best suited for hunters and is well seen in terrain.

Blade material:	Stainless steel
Blade thickness:	2,5 mm
Blade length:	109 mm
Knife length:	226 mm
Total length (sheath included):	250 mm
Item no. 1 pcs box/5 ctn:	13505
Item no. 1 pcs-PinPac 5/ctn:	13506



Morakniv Kansbol Burnt Orange Multi-Mount

The Multi-Mount is a versatile mounting solution that takes your knife use to the next level. It allows the knife to be mounted virtually anywhere you want. It is compatible with the MOLLE standard mounting system. It has strategically placed screw holes and slots for different types of straps. The knife is kept safe in the mount with a hook and loop strap. It allows a secure mounting as well as a fast and easy attachment.

Blade material:	Stainless steel
Blade thickness:	2,5 mm
Blade length:	109 mm
Knife length:	226 mm
Total length (sheath included):	242 mm
Item no. 1 pcs box/5 ctn:	13507

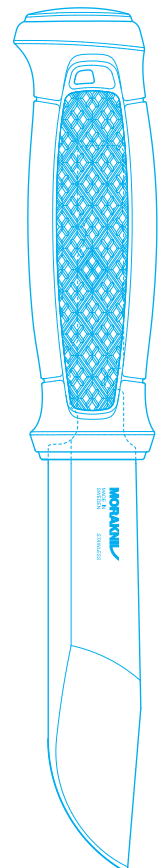



Multi-Mount

Multi-Mount is a versatile mounting solution for Morakniv Garberg and Morakniv Kansbol. You can mount the knife almost wherever you want, and you can attach and detach it fast. Of course it's also possible to take the knife directly out of its sheath for even faster use.

Together with the Multi-Mount fastening system, your knife is just seconds away. Place it on your snowmobile, canoe, or ATV - when the knife is placed in the holder it can take a bumpy ride on any vehicle. Attach and detach the knife from the mount in just a couple of seconds. Of course, it is also possible to just take the knife straight out of the sheath and use it. It is compatible with the MOLLE standard mounting system, and has strategically placed screw holes and slots for different types of straps.

For more information about the possibilities of the Multi-Mount, visit our website and social media for more inspiration.

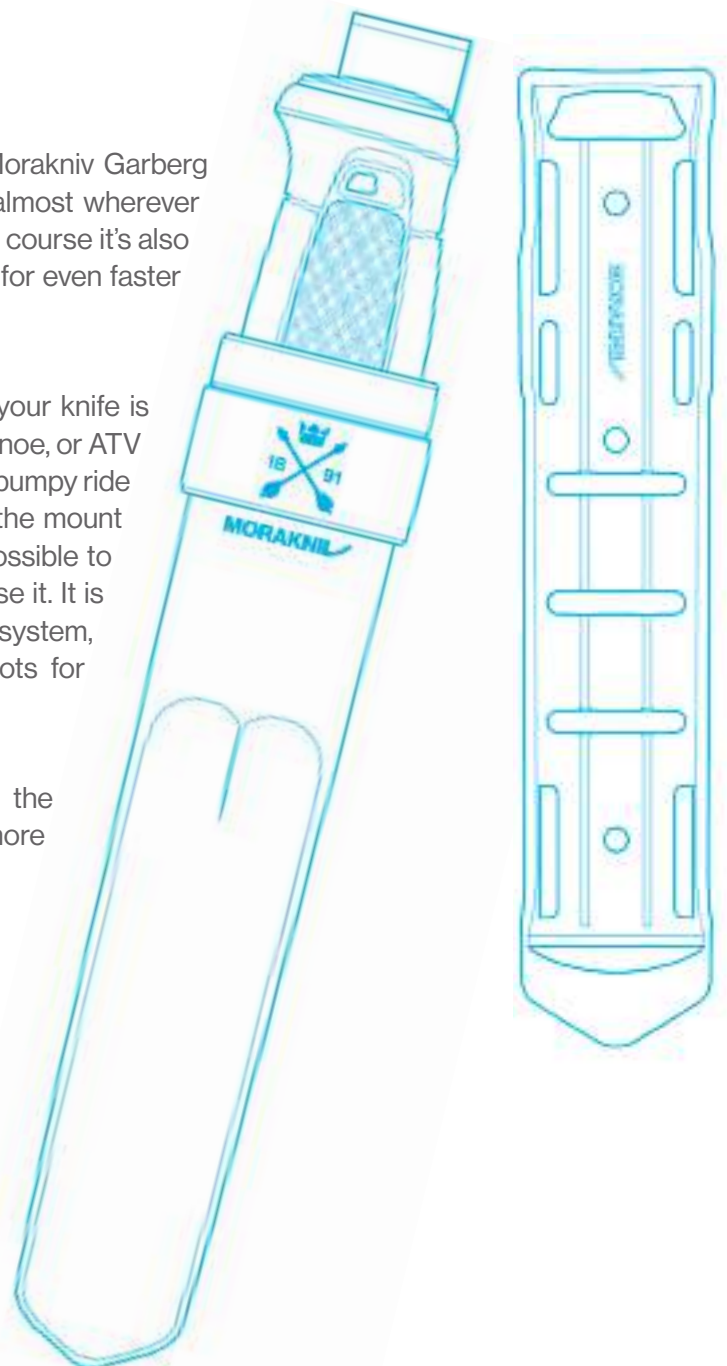

Knife User Guide
Multi-Mount



Knife User Guide
Kansbol

Companion Spark

Morakniv Companion Spark is designed to light the spark on your outdoor adventures. Thanks to the handle-integrated fire starter and the blade's 90° spine, camp fire warmth is always close at hand. To enhance its strength and long-lasting sharpness, the Swedish steel is specially SGM® (Steel Grade Mora) heat treated at our factory in Mora, Sweden. Reducing the risk of misplacing the fire starter in the dark, this knife comes with a reflective paracord. Companion Spark is a part of you and your adventure.



Morakniv Companion Spark Blue

Integrated fire starter in the handle with ergonomic soft friction grip. The color matching sheath is made of polymer that has a practical belt clip for attaching the knife to a rucksack or a belt.

Blade material:	Stainless steel
Blade thickness:	2,5 mm
Blade length:	104 mm
Knife length:	223 mm
Total length (sheath included):	238 mm
Item no. 1 pcs-PinPac /5 ctn:	13572



Morakniv Companion Spark Green

Integrated fire starter in the handle with ergonomic soft friction grip. The color matching sheath is made of polymer that has a practical belt clip for attaching the knife to a rucksack or a belt.

Blade material:	Stainless steel
Blade thickness:	2,5 mm
Blade length:	104 mm
Knife length:	223 mm
Total length (sheath included):	238 mm
Item no. 1 pcs-PinPac /5 ctn:	13570



Morakniv Companion Spark Yellow

Integrated fire starter in the handle with ergonomic soft friction grip. The color matching sheath is made of polymer that has a practical belt clip for attaching the knife to a rucksack or a belt.

Blade material:	Stainless steel
Blade thickness:	2,5 mm
Blade length:	104 mm
Knife length:	223 mm
Total length (sheath included):	238 mm
Item no. 1 pcs-PinPac /5 ctn:	13573



Morakniv Companion Spark Red

Integrated fire starter in the handle with ergonomic soft friction grip. The color matching sheath is made of polymer that has a practical belt clip for attaching the knife to a rucksack or a belt.

Blade material:	Stainless steel
Blade thickness:	2,5 mm
Blade length:	104 mm
Knife length:	223 mm
Total length (sheath included):	238 mm
Item no. 1 pcs-PinPac /5 ctn:	13571



Morakniv Companion Spark Black

Integrated fire starter in the handle with ergonomic soft friction grip. The color matching sheath is made of polymer that has a practical belt clip for attaching the knife to a rucksack or a belt.

Blade material:	Stainless steel
Blade thickness:	2,5 mm
Blade length:	104 mm
Knife length:	223 mm
Total length (sheath included):	238 mm
Item no. 1 pcs-PinPac /5 ctn:	13567



Fire starter

The fire starter is of the highest quality made to perform in any weather condition.

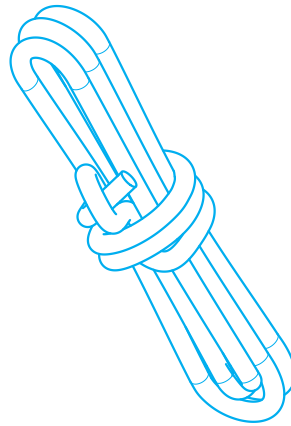
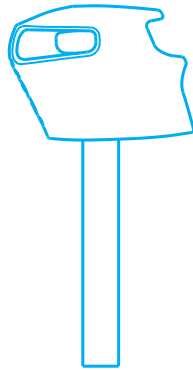

Reflective cord

Companion Spark is equipped with a reflective cord for the fire starter which reduces the risk of misplacing it in the dark.

Polymer

The polymer is made of TPE and provides a grip-friendly handle that allows you to work with power and precision.

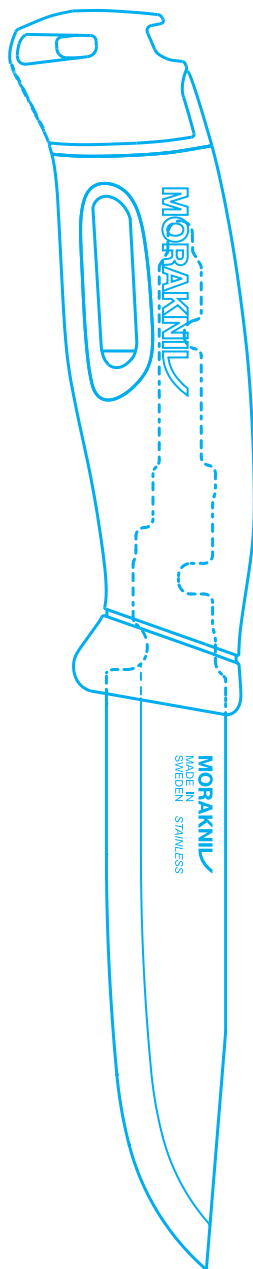

Hole

The holes in the handle make the knife lighter.

Ground spine

The spine of the blade is ground to a 90 degrees angle, making it compatible with the integrated fire starter in the handle. Fire away!

Steel

The blade is 2,5 mm thick and 104 mm long. It is made of 12C27 stainless steel that is treated to the highest quality in our own factory according to our Steel Grade Mora/SGM® Standard.

Companion design

The design of the knife follows the Companion-series with an ergonomic handle and with a 3/4 stick tang that ensures a strong, stable and powerful knife that becomes a natural part of your daily work.

Sheath

The polymer sheath has a practical belt clip for attaching the knife to a rucksack or a belt. It also has a drain hole in the bottom where water can pass through.

Scandi grind

The knife blade is grinded with a Scandi grind which makes it easy to keep sharp.



Companion

Morakniv Companion is an excellent entry-level knife. Developed in the same spirit as our Bushcraft series, it is also your reliable everyday carry. Models added after the preliminary release include everything from MG (Military Green) and Hi-Vis Orange to the bright Color Mix. Ergonomic handle with a soft high friction grip. Blade of stainless steel. Color-matching polymer sheath with a belt clip.



Morakniv Companion Blue

Blade material:	Stainless Steel
Blade thickness:	2,5 mm
Blade length:	104 mm
Knife length:	219 mm
Total length (sheath included):	233 mm
Item No. 15pcs-display:	12159
Item No. 1 pcs-PinPac 5/ctn:	12093



Morakniv Companion Hi-Vis Orange

Blade material:	Stainless Steel
Blade thickness:	2,5 mm
Blade length:	104 mm
Knife length:	219 mm
Total length (sheath included):	233 mm
Item No. 15pcs-display:	11824
Item No. 1 pcs-PinPac 5/ctn:	12090



Morakniv Companion Green

Blade material:	Stainless Steel
Blade thickness:	2,5 mm
Blade length:	104 mm
Knife length:	219 mm
Total length (sheath included):	233 mm
Item No. 15pcs-display:	12158
Item No. 1 pcs-PinPac 5/ctn:	12091



Morakniv Companion Cerise

Blade material:	Stainless Steel
Blade thickness:	2,5 mm
Blade length:	104 mm
Knife length:	219 mm
Total length (sheath included):	233 mm
Item No. 15pcs-display:	12157
Item No. 1 pcs-PinPac 5/ctn:	12094



Morakniv Companion Black

Blade material:	Stainless Steel
Blade thickness:	2,5 mm
Blade length:	104 mm
Knife length:	219 mm
Total length (sheath included):	233 mm
Item No. 15pcs-display:	12141
Item No. 1 pcs-PinPac 5/ctn:	12092



Morakniv Companion Navy Blue

Blade material:	Stainless Steel
Blade thickness:	2,5 mm
Blade length:	104 mm
Knife length:	219 mm
Total length (sheath included):	233 mm
Item No. 15pcs-display:	13164
Item No. 1 pcs-PinPac 5/ctn:	13214



Morakniv Companion Desert

Blade material:	Stainless Steel
Blade thickness:	2,5 mm
Blade length:	104 mm
Knife length:	219 mm
Total length (sheath included):	233 mm
Item No. 15pcs-display:	13166
Item No. 1 pcs-PinPac 5/ctn:	13216



Morakniv Companion Anthracite

Blade material:	Stainless Steel
Blade thickness:	2,5 mm
Blade length:	104 mm
Knife length:	219 mm
Total length (sheath included):	233 mm
Item No. 15pcs-display:	13165
Item No. 1 pcs-PinPac 5/ctn:	13215



Morakniv Companion MG (S)

Blade material:	Stainless Steel
Blade thickness:	2,5 mm
Blade length:	104 mm
Knife length:	219 mm
Total length (sheath included):	233 mm
Item No. 15pcs-display:	11827
Item No. 1 pcs-PinPac 5/ctn:	12215



Morakniv Companion Color mix

Blade material:	Stainless Steel
Blade thickness:	2,5 mm
Blade length:	104 mm
Knife length:	219 mm
Total length (sheath included):	233 mm
Item No. 15pcs-display:	12884



Morakniv Companion Color mix Adventure

Blade material:	Stainless Steel
Blade thickness:	2,5 mm
Blade length:	104 mm
Knife length:	219 mm
Total length (sheath included):	233 mm
Item No. 15pcs-display:	13089



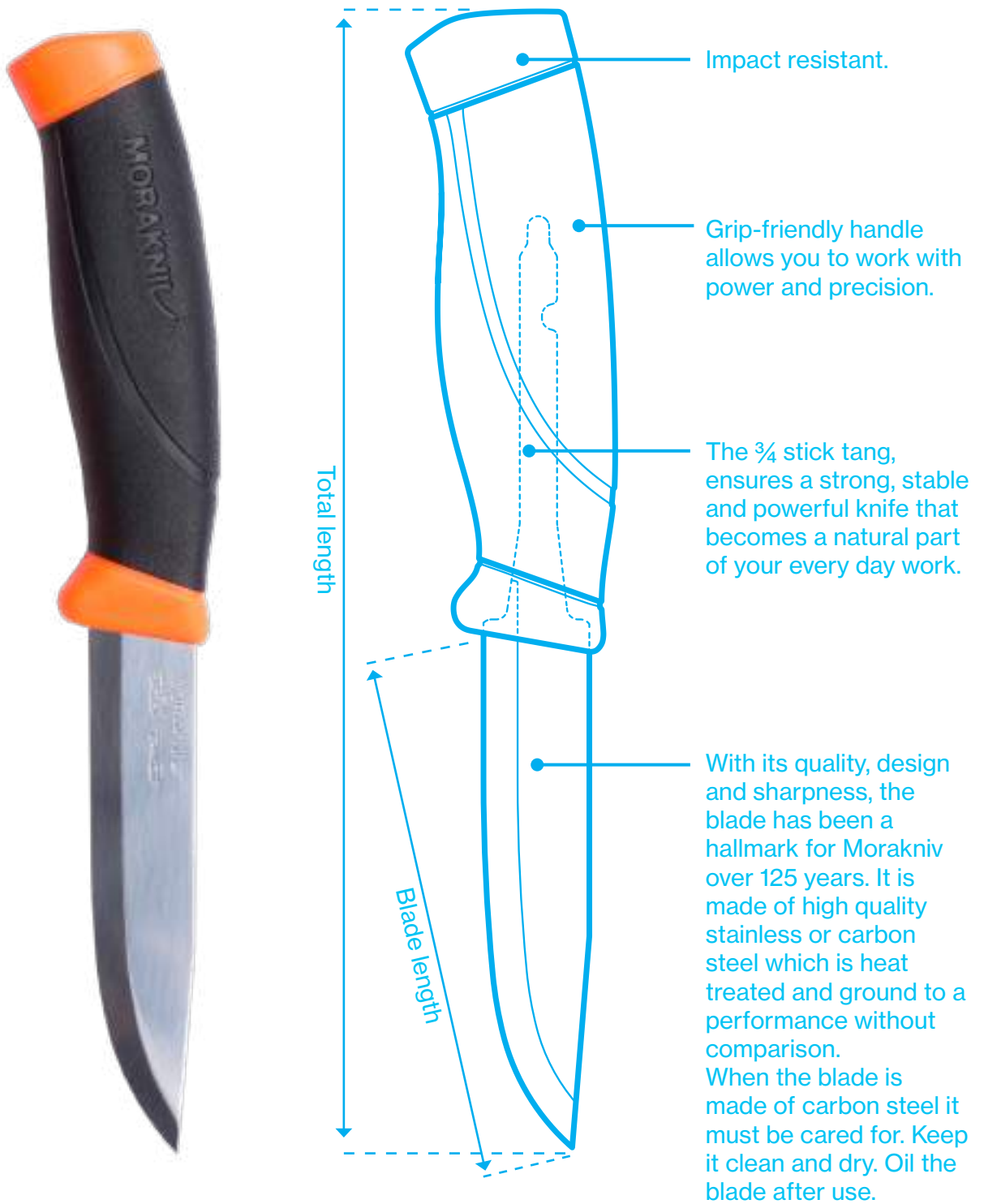

A reliable Companion

Companion is our ultimate all-round knife and also one of our most popular models. There's something for everybody amongst the different knives, whether you're planning a trip to the hut by the lake or a more survival-themed adventure. The basic Companion model is a perfect entry-level model for young or new knife users. After that it's simply about advancing and continuing to discover. Choose between stainless or carbon steel, find your favorite color, or think about whether you need a somewhat thicker blade. There's a Companion for everybody.



Morakniv Companion Hi-Vis Rescue

Blade of stainless steel with a serrated blade, perfect for cutting rope, nylon and fiber. The safety tip prevents injuries. The red high visible polymer sheath makes it easy to locate the knife. The sheath comes with a belt clip.

Blade material:	Stainless steel
Blade thickness:	2,5 mm
Blade length:	99 mm
Knife length:	214 mm
Total length (sheath included):	233 mm
Item no. 15pcs-display:	11828



Morakniv Companion Serrated Hi-Vis Orange

The serrated edge has been developed for cutting rope, nylon and fiber. The stainless steel stays sharp for a long time - so you can focus on the job at hand. The polymer sheath is high visible and comes with a belt clip.

Blade material:	Stainless steel
Blade thickness:	2,5 mm
Blade length:	104 mm
Knife length:	214 mm
Total length (sheath included):	233 mm
Item no. 15pcs-display:	11829



Morakniv Companion MG (C)

Blade of carbon steel. Contoured high friction grip. Dark green polymer sheath with a belt clip. Non-ground blade spine.

Blade material:	Carbon steel
Blade thickness:	2,0 mm
Blade length:	104 mm
Knife length:	214 mm
Total length (sheath included):	233 mm
Item no. 15pcs-display:	11863
Item no. 1 pcs-PinPac 5/ctn:	12216



Morakniv Companion HeavyDuty Hi-Vis Orange (C)

Powerful tool with a slightly thicker blade of carbon steel and an extra large ergonomic handle with a soft high friction grip. The color provides high visibility and makes it easy to locate in all conditions.

Blade material:	Carbon steel
Blade thickness:	3,2 mm
Blade length:	104 mm
Knife length:	224 mm
Total length (sheath included):	240 mm
Item no. 1 pcs-PinPac 5/ctn:	12211
Item no. 1 pcs-box 20/ctn:	12495



Morakniv Companion HeavyDuty MG (C)

The knife has a slightly thicker blade of carbon steel with high load capacity that is easily re-sharpened. A very powerful and reliable knife in a color that blends in with your equipment. Polymer sheath with a belt clip.

Blade material:	Carbon steel
Blade thickness:	3,2 mm
Blade length:	104 mm
Knife length:	224 mm
Total length (sheath included):	240 mm
Item no. 1 pcs-PinPac 5/ctn:	12210
Item no. 1 pcs-box 20/ctn:	12494
NATO no.:	NSN 1095-64-000-4080



Morakniv Companion HeavyDuty Burnt Orange

The knife has a slightly thicker blade of stainless steel with high load capacity that is easily re-sharpened. A very powerful and reliable knife in a color that blends in with your equipment. Polymer sheath with a belt clip.

Blade material:	Stainless steel
Blade thickness:	3,2 mm
Blade length:	104 mm
Knife length:	224 mm
Total length (sheath included):	240 mm
Item no. 1 pcs-PinPac 5/ctn:	13259
Item no. 1 pcs-box 20/ctn:	13260



Morakniv Companion HeavyDuty Black (S)

The knife has a slightly thicker blade of stainless steel with high load capacity that is easily re-sharpened. A very powerful and reliable knife. Polymer sheath with a belt clip.

Blade material:	Stainless steel
Blade thickness:	3,2 mm
Blade length:	104 mm
Knife length:	224 mm
Total length (sheath included):	240 mm
Item no. 1 pcs-PinPac 5/ctn:	13158
Item no. 1 pcs-box 20/ctn:	13159

Children and Junior

It's completely silent and concentration is total. All focus is on carving the stick, sliver by sliver, on carefully evening out the edges of the piece of wood. Is it going to be a bark boat? A barbecue stick? Or maybe even a butter knife? Working with a knife and a carving subject can give long moments of pleasure. It gives an almost meditative feeling of being in the present for adults and children alike.

As always when working with a knife, one needs to have respect for the tool, both adults and children. When we carve wood together with children, we need to be aware of what we do with the knife, how we carve and how we behave. Here we've collected a set of models that are suitable for work with younger apprentices.

Given that these are mainly intended for younger knife users, the safety aspect is of course of primary importance. The handle is adapted for children's hands, the finger guard prevents fingers from sliding down onto the blade, and the rounded point prevents pricking injuries.



Morakniv Scout 39

A classic outdoor knife with double finger protection and a birch wood handle. Blade of Swedish stainless steel. Bright leather sheath.

Blade material:	Stainless steel
Blade thickness:	2,0 mm
Blade length:	87 mm
Knife length:	180 mm
Total length (sheath included):	197 mm
Item no. 1 pcs-PinPac /5 ctn:	11843



Junior Carving Knife 73/164

Carving knife for children with a carbon steel blade. Oiled birch wood handle. Polymer sheath.

Blade material:	Carbon steel
Blade thickness:	2,5 mm
Blade length:	76 mm
Knife length:	170 mm
Total length (sheath included):	200 mm
Item no. 10 pcs-bulk:	111-2103
Item no. 1 pcs PinPac /5 ctn:	12154



Morakniv Rookie

A knife with an extra round tip perfect for the knife rookie. Stainless steel blade and handle made of birch wood. Black polymer sheath.

Blade material:	Stainless steel
Blade thickness:	2,0 mm
Blade length:	72 mm
Knife length:	166 mm
Total length (sheath included):	200 mm
Item no. 1 pcs-PinPac /5 ctn:	12991





Morakniv Scout 39 Safe, Blue

A classic outdoor knife with double finger protection and a birch wood handle. The knife has a blade of Swedish stainless steel with a blunt safety tip. The knives have a black leather sheath. We use non-toxic paints.

Blade material:	Stainless steel
Blade thickness:	2,0 mm
Blade length:	85 mm
Knife length:	178 mm
Total length (sheath included):	195 mm
Item no. 1 pcs-PinPac /5 ctn:	12021



Morakniv Scout 39 Safe, Cerise

A classic outdoor knife with double finger protection and a birch wood handle. The knife has a blade of Swedish stainless steel with a blunt safety tip. The knives have a black leather sheath. We use non-toxic paints.

Blade material:	Stainless Steel
Blade thickness:	2,0 mm
Blade length:	85 mm
Knife length:	178 mm
Total length (sheath included):	195 mm
Item No. 1 pcs-PinPac 5/ctn:	12024



Morakniv Scout 39 Safe, Green

A classic outdoor knife with double finger protection and a birch wood handle. The knife has a blade of Swedish stainless steel with a blunt safety tip. The knives have a black leather sheath. We use non-toxic paints.

Blade material:	Stainless Steel
Blade thickness:	2,0 mm
Blade length:	85 mm
Knife length:	178 mm
Total length (sheath included):	195 mm
Item No. 1 pcs-PinPac 5/ctn:	12022



Morakniv Scout 39 Safe, Orange

A classic outdoor knife with double finger protection and a birch wood handle. The knife has a blade of Swedish stainless steel with a blunt safety tip. The knives have a black leather sheath. We use non-toxic paints.

Blade material:	Stainless Steel
Blade thickness:	2,0 mm
Blade length:	85 mm
Knife length:	178 mm
Total length (sheath included):	195 mm
Item No. 1 pcs-PinPac 5/ctn:	12287



Morakniv Scout 39 Safe, Black

A classic outdoor knife with double finger protection and a birch wood handle. The knife has a blade of Swedish stainless steel with a blunt safety tip. The knives have a black leather sheath. We use non-toxic paints.

Blade material:	Stainless Steel
Blade thickness:	2,0 mm
Blade length:	85 mm
Knife length:	178 mm
Total length (sheath included):	195 mm
Item No. 1 pcs-PinPac 5/ctn:	12480



Morakniv Scout 39 Safe, Colormix

A classic outdoor knife with double finger protection and a birch wood handle. The knife has a blade of Swedish stainless steel with a blunt safety tip. The knives have a black leather sheath. We use non-toxic paints.

Blade material:	Stainless Steel
Blade thickness:	2,0 mm
Blade length:	85 mm
Knife length:	178 mm
Total length (sheath included):	195 mm
Item No. 15-display:	12885

The traditional Scout knife

For many, the Scout knife is the first contact with a knife as a tool and carving a piece of bark or a stick invokes memories of childhood summers. The small handle and double finger guard have been standout features of these colorful knives. With this in your rucksack, you always were, and are, ready for a trip into nature.

The Scout knives were developed at the beginning of the 1930's. When this knife first saw the light of day, the new, flat knife sheath was a differentiating detail. It was both simple to sew and manufacture, so the entire knife became commercially viable and popular.

From a production standpoint, it was also a plus that the knife sheaths were made of leather, flat and easy to sew. But since those times, the Scout knife has become an even more popular model – maybe just because of the handy size and the smooth, flat cover.

Fishing

These models are perfect for your fishing trip so you can descale your catch of the day with ease. The blades are simple to work with, while the convenient size and knife cover make it easy to keep in your rucksack or belt. You just need to cast off and wait for a bite. The combination of the blades and the rubber handles make these knives optimal for fishing when you need to be able to work safely and efficiently in damp environments. The patterned friction grip made of TPE rubber reduces the risk of slipping if your hands are wet. What's more, rubber doesn't conduct cold, making the knife convenient to work with all year round.



Morakniv Fishing Comfort Fillet 155

A long filleting knife with a blade of Swedish stainless steel. Patterned high-friction grip handle. Polymer EasyClean sheath with two interchangeable belt clips.

Blade material:	Stainless steel
Blade thickness:	1,9 mm
Blade length:	155 mm
Knife length:	270 mm
Total length (sheath included):	290 mm
Item no. 1 pcs-PinPac /5 ctn:	11892



Morakniv Fishing Comfort Scaler 150

A long allround knife with a serrated back for scaling, and a blade of Swedish stainless steel. Patterned high-friction grip and a polymer Easy Clean sheath with two interchangeable belt clips.

Blade material:	Stainless steel
Blade thickness:	2,0 mm
Blade length:	150 mm
Knife length:	265 mm
Total length (sheath included):	290 mm
Item no. 1 pcs-PinPac /5 ctn:	11893



Morakniv Fishing Comfort Fillet 090

Short filleting knife with a blade of Swedish stainless steel. Patterned high-friction grip handle.

Blade material:	Stainless steel
Blade thickness:	1,3 mm
Blade length:	90 mm
Knife length:	200mm
Total length (sheath included):	230mm
Item no. 1 pcs-PinPac /5 ctn:	12207



Morakniv Fishing Comfort Scaler 098

Short cleaning knife with a serrated back for scaling. Suitable for carving. Blade of Swedish stainless steel. Patterned high-friction grip handle.

Blade material:	Stainless steel
Blade thickness:	2,0 mm
Blade length:	98 mm
Knife length:	214 mm
Total length (sheath included):	230 mm
Item no. 1 pcs-PinPac /5 ctn:	12208



Bushcraft

Bushcraft is about getting to know nature, about having the knowledge needed to be in nature and survive there. It can include knowing which plants you can eat, how to make fire, or how to use a knife and an axe. We've kept these skills in mind when designing our Bushcraft knives.

These are knives with sturdy blades that withstand splitting wood and are adapted to use with a fire starter. Certain models have both a fire starter and diamond sharpener integrated in the sheath so that you really have everything you need in one place. The handles are made of an easy-grip polymer so that the knife always feels steady and safe in your hands when it's time to work.



Morakniv Survival Hi-Vis Orange

The razor sharp stainless steel blade has a distinct tip. The robust highly visible sheath is provided with a fire starter as well as a diamond sharpener. The spine of the blade has been ground especially for use with the fire starter. The sheath comes with an interchangeable belt clip and a belt loop. The handle has a high-friction grip.

Blade material:	Stainless steel
Blade thickness:	3,2 mm
Blade length:	109 mm
Knife length:	232 mm
Total length (sheath included):	258 mm
Item no. 1 pcs-PinPac /5 ctn:	12051



Morakniv Survival Black

An anticorrosive blade of black coated high carbon steel. The robust sheath is provided with a fire starter and completed with a diamond sharpener, making it easy to sharpen the knife blade. The spine of the blade has been ground especially for use with the fire starter. The sheath comes with an interchangeable belt clip and a belt loop. The handle has a high-friction grip.

Blade material:	Carbon steel
Blade thickness:	3,2 mm
Blade length:	109 mm
Knife length:	232 mm
Total length (sheath included):	258 mm
Item no. 1 pcs-PinPac /5 ctn:	11742



Morakniv Survival Desert

An anticorrosive blade of stainless steel. The robust sheath is provided with a fire starter and completed with a diamond sharpener, making it easy to sharpen the knife blade. The spine of the blade has been ground especially for use with the fire starter. The sheath comes with an interchangeable belt clip and a belt loop. The handle has a high-friction grip.

Blade material:	Stainless steel
Blade thickness:	3,2 mm
Blade length:	109 mm
Knife length:	232 mm
Total length (sheath included):	258 mm
Item no. 1 pcs-PinPac /5 ctn:	13033



Morakniv Bushcraft Black SRT

It is sturdy, robust and the SRT model has a half-serrated blade - perfect for cutting rope and fiber. The stainless steel makes the blade easy to maintain, and the DLC-coating decreases blade reflections. The spine is ground especially for use with a fire starter. It comes with a polymer sheath, loop and interchangeable belt clip. The handle has a high-friction grip.

Blade material:	Stainless steel
Blade thickness:	3,2 mm
Blade length:	109 mm
Knife length:	232 mm
Total length (sheath included):	258 mm
Item no. 1 pcs-box /20 ctn:	12491



Morakniv Bushcraft Black

A sturdy knife with a blade of specially heat treated carbon steel that is very resistant to breakage. The black DLC-coating protects against corrosion and prevents blade reflections. The spine is ground specially for use with a fire starter. It comes with a polymer sheath with loop and interchangeable belt clip. The handle has a high-friction grip.

Blade material:	Carbon steel
Blade thickness:	3,2 mm
Blade length:	109 mm
Knife length:	232 mm
Total length (sheath included):	258 mm
Item no. 1 pcs-PinPac /5 ctn:	10791
Item no. 1 pcs-box /20 ctn:	12490



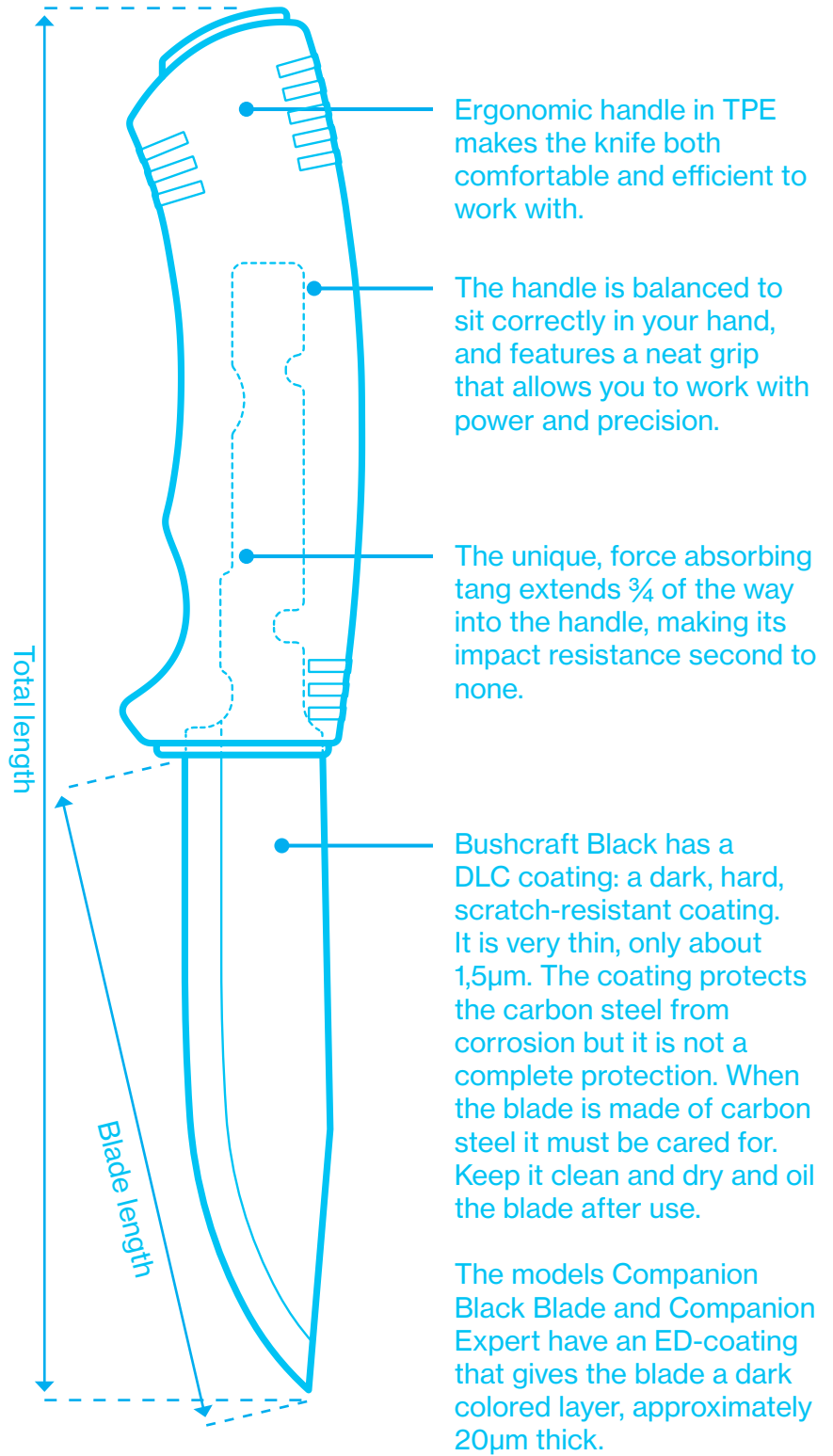



Morakniv Bushcraft Forest

With a discrete forest green grip and a polymer sheath of the same color, this model is the perfect forest saviour. The slightly thinner, profile ground blade is made of Swedish stainless steel.

Blade material:	Stainless steel
Blade thickness:	2,5 mm
Blade length:	109 mm
Knife length:	232 mm
Total length (sheath included):	258 mm
Item no. 1 pcs-PinPac 5/ctn:	12356
Item no.1 pcs-box 20/ctn:	12493



Morakniv Bushcraft Hi-Vis Orange

The orange grip and sheath make the knife highly visible. The Swedish stainless steel, tempered according to our secret recipe, ensures that the blade stays sharp for a long time, is extremely tolerant and has considerable cutting strength. The spine is ground especially for use with a fire starter. The sheath comes with a loop and interchangeable belt clip.

Blade material:	Stainless steel
Blade thickness:	3,2 mm
Blade length:	109 mm
Knife length:	232 mm
Total length (sheath included):	258 mm
Item no.1 pcs-box /20 ctn:	12492



Morakniv Pathfinder

A model with a longer blade of high carbon steel with a black anticorrosive DLC-coating. The spine of the blade is ground specially for use with a fire starter and comes with a MOLLE-compatible sheath of heavy-duty nylon.

Blade material:	Carbon steel
Blade thickness:	3,2 mm
Blade length:	170 mm
Knife length:	296 mm
Item no. 1 pcs-box 12/ctn:	12355



Morakniv Fire Starter

Bring the Fire Starter on your outdoor tour and be able to light a fire wherever you are. Just pull a knife blade with a specially ground back/spine slowly and heavily along the fire starter. The sparks easily light your barbecue, birch bark or dry grass.

Thickness:	8 mm
Length:	65 mm
Total length:	99 mm
Item No. 1 pcs-PinPac 5/ctn:	11859



Expert

If you're out in tough terrain or in the field you need equipment that performs. That's why our Expert knives have robust blades and advanced attachment possibilities. Whatever is needed to make sure your knife is near at hand in situations when it needs to be. The term Expert is meant to reflect the material that has been developed for military users. However, it hasn't prevented bushcrafters and other adventurers from discovering the charm of this range of knives. A steady grip, a sturdy blade and pure strength are good to have in tough terrain.

Our Expert range of knives is a further development of Buschcraft Black and similar knives. We deliver to both the Swedish military forces and special forces all around the world, so we've developed a range of knives that fulfill the needs of being out in the field. It's simply about creating solid and robust tools that must always perform in tough situations. Aside from the knife, we have enhanced the knife sheath with a nylon MOLLE cover that allows the knife to attach to MOLLE jackets for example. A very flexible and much used assembly system for military users all over the world.



Morakniv Companion MG (S)

Blade of Swedish stainless steel. The soft friction grip is made of TPE rubber, making the knife feel secure and steady to work with. The polymer knife sheath includes a practical belt clip so that the knife can be attached to your rucksack or belt – always close at hand. The dark green color makes it discrete and blends smoothly into the environment.

Blade material:	Stainless Steel
Blade thickness:	2,5 mm
Blade length:	104 mm
Knife length:	219 mm
Total length (sheath included):	233 mm
Item No. 15pcs-display:	11827
NATO No.:	NSN 7340-38-001-3098

Also available:

Item No. 1 pcs-PinPac 5/ctn:	12215
NATO No.:	NSN 7340-38-001-3098



Morakniv Survival Black

An anticorrosive blade of black coated high carbon steel. The robust sheath is provided with a fire starter and completed with a diamond sharpener, making it easy to sharpen the knife blade. The spine of the blade has been ground especially for use with the fire starter. The sheath comes with an interchangeable belt clip and a belt loop. Handle with a high-friction grip.

Blade material:	Carbon Steel
Blade thickness:	3,2 mm
Blade length:	109 mm
Knife length:	232 mm
Total length (sheath included):	258 mm
Item No. 25 pcs:	12880
NATO No.:	NSN 1095-99-614-9805

Also available:

Item No. 5 pcs-PinPac 5/ctn:	11742
NATO No.:	NSN 1095-99-614-9805



Morakniv 2000 | Green

The perfect outdoor knife with just the right feel. The discrete green color of the handle and the sheath makes the knife easy to hide - it blends in with the surroundings and your other equipment. Blade of stainless steel.

Blade material:	Stainless Steel
Blade thickness:	2,5 mm
Blade length:	109 mm
Knife length:	224 mm
Total length (sheath included):	253 mm
Item No. 15pcs-display:	10629
Swedish Armed Forces No.:	M6310-004610



Morakniv®



Morakniv Bushcraft Expert SRT

The half-serrated blade is perfect for cutting rope and fiber, and the stainless steel with a black anticorrosive DLC-coating is outstandingly sharp. The spine of the blade is ground especially for use with a fire starter. It comes with a MOLLE-compatible sheath of heavy-duty nylon.

Blade material:	Stainless Steel
Blade thickness:	3,2 mm
Blade length:	109 mm
Knife length:	232 mm
Total length (sheath included):	265 mm
Item No. 1 pcs-box 20/ctn:	12295



Morakniv Bushcraft Expert

A first rate knife that is ideal for all sorts of field and outdoor tasks. The knife has an anti-corrosive black DLC-coating and a blade of high carbon steel. This combination protects the knife against corrosion as well as making it razor sharp. In other words: the knife is always ready to perform the tasks required. The spine of the blade is ground especially for use with a fire starter. It comes with a MOLLE-compatible sheath of heavy-duty nylon.

Blade material:	Carbon Steel
Blade thickness:	3,2 mm
Blade length:	109 mm
Knife length:	232 mm
Total length (sheath included):	265 mm
Item No. 1 pcs-box 20/ctn:	12294



Morakniv Garberg Black C – Multi-Mount

This blackened Carbon full tang knife is designed to meet the long-time wishes from our most dedicated users. The blade has a Scandi-grind profile that makes it easy to keep sharp and a ground spine compatible with a fire starter. The black blade has a DLC coating: a dark, hard, scratch-resistant coating. It is very thin, only about 1,5µm. The coating helps to protect the carbon steel from corrosion. Available with MultiMount or black leather sheath.

Blade material:	Carbon Steel
Blade thickness:	3,2 mm
Blade length:	109 mm
Knife length:	229 mm
Total length (sheath included):	245 mm
Item No. 1 pcs box/5 ctn:	13147

Morakniv Garberg Black C – Leather sheath

Item No. 1 pcs box/5 ctn:	13100
---------------------------	-------



Morakniv Kansbol

The sheath is made of polypropylene, a polymer that makes it rugged, and thereby provides an excellent protection of the knife. Both the handle and the sheath are symmetrical, which enables both left and right hand use. It also allows you to place the knife in the sheath from both sides.

Blade material:	Stainless Steel
Blade thickness:	2,5 mm
Blade length:	109 mm
Knife length:	226 mm
Total length (sheath included):	250 mm
Item No. 1 pcs box/5 ctn:	12634
Item No. 1 pcs-PinPac 5/ctn:	12872
Swedish Armed Forces No.:	M6310-014010



Multi-Mount kit for Kansbol

A Multi-Mount kit for Kansbol. Includes three Velcro-straps, a loop collar and a secondary locking collar.

Item No. 1 pcs bag/15 ctn:	12973
Swedish Armed Forces NO.:	M6310-014019
<i>Also available:</i>	
Item No. 1 pcs box/5 ctn	13002



Morakniv Eldris Black

Blade material:	Stainless Steel
Blade thickness:	2 mm
Blade length:	59 mm
Knife length:	143 mm
Total length (sheath included):	152 mm
Item No. 1 pcs box/5 ctn:	12647
Item No. 1 pcs-PinPac 5/ctn:	12870

Morakniv Eldris with Kit Black

Item No. 1 pcs box/5 ctn:	12629
Item No. 1 pcs-PinPac 5/ctn:	12865



Morakniv Bushcraft Expert Sheath

Item no. 1 pcs-box 5/ctn:	13004
---------------------------	-------



Morakniv Companion Expert Sheath

Item no. 1 pcs-box 5/ctn:	13005
---------------------------	-------



MOLLE-compatible sheath with Pouch Attachment Ladder System (PALS) provides multiple carrying options and ensures that your knife is always within reach.

Mushroom knives

Take good care of your mushroom pickings. Our Karl-Johan is your best tool for cleaning out gilled mushrooms, ceps and everything in between. This 55 mm long mushroom knife is made of Swedish stainless steel. The handle has been ergonomically shaped and is comfortable to hold in your hand. Its brush is made of real horsehair so you can remove dirt without damaging the mushroom. It has a practical edge cover, which means you can hang Karl Johan on your belt or buttonhole – always close at hand for when the forest's treasures suddenly appear.



Morakniv Mushroom Knife | Red

Blade of Swedish stainless steel. Ergonomically designed polymer handle, very pleasant to hold. Brush made from real horse hair. Can be hung from your belt, keeping it within reach.

Blade material:	Stainless Steel
Blade thickness:	1,6 mm
Blade length:	62 mm
Knife length:	141 mm
Total length (sheath included):	152 mm
Item No. 1 pcs-PinPac 5/ctn:	12206



Morakniv Mushroom Knife | Black

Blade of Swedish stainless steel. Ergonomically designed polymer handle, very pleasant to hold. Brush made from real horse hair. Can be hung from your belt, keeping it within reach.

Blade material:	Stainless Steel
Blade thickness:	1,6 mm
Blade length:	62 mm
Knife length:	141 mm
Total length (sheath included):	152 mm
Item No. 1 pcs-PinPac 5/ctn black:	10906



Morakniv Mushroom Knife | Lime

Blade of Swedish stainless steel. Ergonomically designed polymer handle, very pleasant to hold. Brush made from real horse hair. Can be hung from your belt, keeping it within reach.

Blade material:	Stainless Steel
Blade thickness:	1,6 mm
Blade length:	62 mm
Knife length:	141 mm
Total length (sheath included):	152 mm
Item No. 1 pcs-PinPac 5/ctn lime:	10935



Morakniv Mushroom Knife | Color Mix

Blade of Swedish stainless steel. Ergonomically designed polymer handle, very pleasant to hold. Brush made from real horse hair. Can be hung from your belt, keeping it within reach.

Blade material:	Stainless Steel
Blade thickness:	1,6 mm
Blade length:	62 mm
Knife length:	141 mm
Total length (sheath included):	152 mm
Item No. 100 pcs-bulk color mix:	12886
Item No. 1 pcs-PinPac 5/ctn color mix:	12887





Hunting and general outdoor

Demanding outdoor users who actively target specific brands and products know that the Morakniv brand stands for top quality, sharpness, a long service life and an attractive design, combined with a feeling of true authenticity. Our Outdoor range features knives to suit your personality, passion and pursuits.

Our knives are extremely sharp and remain so for a long time. They are balanced to sit correctly in the hand and feature a neat grip that allows you to work with both power and precision. The feeling of being in full control makes it possible for you to perform vital and important tasks with total trust in your knife. No matter where you are and what you do - your knife is a natural part of you.



Morakniv 510

The wilderness blade, ideal for woodworking performance. Light and very sharp with an impact resistant black handle. Blade of carbon steel.

Blade material:	Carbon Steel
Blade thickness:	2,0 mm
Blade length:	95 mm
Knife length:	208 mm
Total length (sheath included):	235 mm
Item No. 15pcs-display:	11732



Morakniv Marine Rescue 541

Impact resistant black handle with substantial finger protection. The contoured grip ensures safe handling in marine environments. Serrated edge with blunt tip to prevent injuries. Blade of Swedish stainless steel. Polymer sheath.

Blade material:	Stainless Steel
Blade thickness:	2,0 mm
Blade length:	91 mm
Knife length:	198 mm
Total length (sheath included):	228 mm
Item No. 20 pcs-bulk:	11529



Morakniv 748 MG

The blade is made of high quality stainless steel, that is easy to maintain and remains sharp for longer. The ergonomically shaped handle and the patterned friction grip simplify your work and the solid finger guard increases safety even further.

Blade material:	Stainless Steel
Blade thickness:	2,5 mm
Blade length:	148 mm
Knife length:	276 mm
Total length (sheath included):	308 mm
Item No. 1 pcs/box, 12 pcs-ctn:	12475





Morakniv 2000 | Orange

If the green version of this model is easy to hide - the orange one is easy to find. The orange details of the handle and the matching sheath provide high visibility. Blade of stainless steel.

Blade material:	Stainless Steel
Blade thickness:	2,5 mm
Blade length:	109 mm
Knife length:	224 mm
Total length (sheath included):	253 mm
Item No. 15pcs-display:	12057



Morakniv Outdoor Axe | Orange

The blade of the axe is made of boron steel with a black ED coating, and comes with a black leather protective cover. The reinforced polypropylene handle provides a firm grip. It's perfect together with your Mora 2000 knife in the same color. Axe head with ED coated boron steel. Weight 0.5 kg.

Blade material:	Boron Steel
Blade thickness:	6 mm
Blade length:	115 mm
Axe length:	330 mm
Total length (sheath included):	335 mm
Item No. 1 pcs-box 5/ctn:	12058



Morakniv Outdoor Kit | Orange

An excellent combination of the outdoor classic Mora 2000 and our popular outdoor axe. The allround knife with its profile grind is perfect when working with your game. When the robust and sturdy boron steel axe is added to the gear, you're more than ready to head out into the woods.

Blade material:	Boron/Stainless Steel
Blade thickness:	6 mm/2,5 mm
Blade length:	115/109 mm
Blade length:	115/109 mm
Total length (sheath included):	335/253 mm
Item No. 1 pcs-box 5/ctn:	12096



Morakniv 2000 | Green

The perfect outdoor knife with just the right feel. The discrete green color of the handle and the sheath makes the knife easy to hide - it blends in with the surroundings and your other equipment. Blade of stainless steel.

Blade material:	Stainless Steel
Blade thickness:	2,5 mm
Blade length:	109mm
Knife length:	224 mm
Total length (sheath included):	253 mm
Item No. 15pcs-display:	10629



Morakniv Outdoor Axe | MG

The blade of the axe is made of boron steel with a black ED coating, and comes with a black leather protective cover. The reinforced polypropylene handle provides a firm grip. It's perfect together with your Mora 2000 knife in the same color. Axe head with ED coated boron steel. Weight 0.5 kg.

Blade material:	Boron Steel
Blade thickness:	6 mm
Blade length:	109 mm
Axe length:	330 mm
Total length (sheath included):	335 mm
Item No. 1 pcs-box 5/ctn:	1-1991
NATO No.:	NSN 5110226254706



Morakniv Outdoor Kit | MG

An excellent combination of the outdoor classic Mora 2000 and our popular outdoor axe. The allround knife with its profile grind is perfect when working with your game. When the robust and sturdy boron steel axe is added to the gear, you're more than ready to head out into the woods.

Blade material:	Boron/Stainless Steel
Blade thickness:	6 mm/2,5 mm
Blade length:	115/109 mm
Blade length:	115/109 mm
Total length (sheath included):	335/253 mm
Item No. 1 pcs-box 5/ctn:	1-2001



Morakniv Belly Opener

Blade of Swedish stainless steel with inside edge. Polymer handle. Polymer EasyClean sheath.

Blade material:	Stainless Steel
Blade thickness:	2,0 mm
Blade length:	63 mm
Knife length:	186 mm
Total length (sheath included):	225 mm
Item No. 10 pcs-bulk:	11453



Morakniv Hunting Set | Orange

Set of two knives with a sharpening steel that is packaged in a practical and durable container. The knives have blades of Swedish stainless steel.

Blade material:	Stainless Steel
Blade thickness:	1,5mm/1,6 mm
Blade length:	132mm/145 mm
Total length (sheath included):	286mm/268 mm
Item No. 1 pcs-box:	12098



Morakniv® Craft

A part of your workmanship

That sensation of working with your hands. Feel the rough wooden object become smoother and smoother, see how it starts to take the shape of a butter knife or a cup. The pleasure as the porch develops, plank by plank. The early morning sleepiness that slips away as you work with the day's wires, walls and waterpipes. All those moments when Morakniv is there with you, on your belt or in your toolbox.

The classic red knife from Mora is well known to many. It pops up in our summer cabin, garage and tool shed when we least expect it. The patina of the blade and its well-worn handle often boast of all the memories that have been created around it. And that's exactly where it should be: in those everyday moments that become ultimately unforgettable. Whether in the shape of a handicraft knife or a building knife, we're always on top of mind, just as we have been for centuries.



MORAKNIV ✓

MORAKNIV ✓

MORAKNIV ✓

MORAKNIV ✓
MADE IN SWEDEN
CARBON

MORAKNIV ✓
MADE IN SWEDEN
CARBON

Basic for professionals

We gave these knives an impact resistant handle with a geometry that fits perfect in your hand. The finger guard has been developed to optimize safety. The blades have a perfect balance between length and width, which gives a better experience when using the knives. The carefully chosen knife steel is also hardened in Mora, Sweden according to our SGM® (Steel Grade Mora) standard. The sheath is the same as the one accompanying Morakniv Pro.



Morakniv Basic 511

The blade is of high quality carbon steel that is easy to re-sharpen. Carbon steel can be affected by moisture and corrosive environments. Take therefore the habit of wiping off the knife and use oil on the blade after use.

Blade material:	Carbon steel
Blade thickness:	2,0 mm
Blade length:	91 mm
Knife length:	206 mm
Total length (sheath included):	224 mm
Item no. 15 pcs-display:	12147
NATO no.:	NSN 5110410030472
Item no. 15 pcs-display sealed:	12428
Item no. 100 pcs-bulk:	13189
Item no. 40 pcs-bucket:	12320



Morakniv Basic 546

Carefully chosen blade of stainless steel which stays sharp for a long time. It is the best choice when working in an outdoor environment.

Blade material:	Stainless steel
Blade thickness:	2,0 mm
Blade length:	91 mm
Knife length:	206 mm
Total length (sheath included):	224 mm
Item no. 15 pcs-display:	12241
Item no. 15 pcs-display sealed:	12429



Morakniv Basic 511 - 2020 Carbon



Morakniv Basic 546 - 2020 Stainless



Color of the Year 2020

Blade is of high quality carbon steel that is easy to re-sharpen (Basic 511), or stainless steel (Basic 546).

Height:	1060 mm
Length:	300 mm
Width:	400 mm
Item no. 1-pcs: (Basic 511 display)	13710
Item no. 1-pcs: (Basic 546 display)	13711
Item no. 1-pcs: (sealed Basic 546 display)	13712





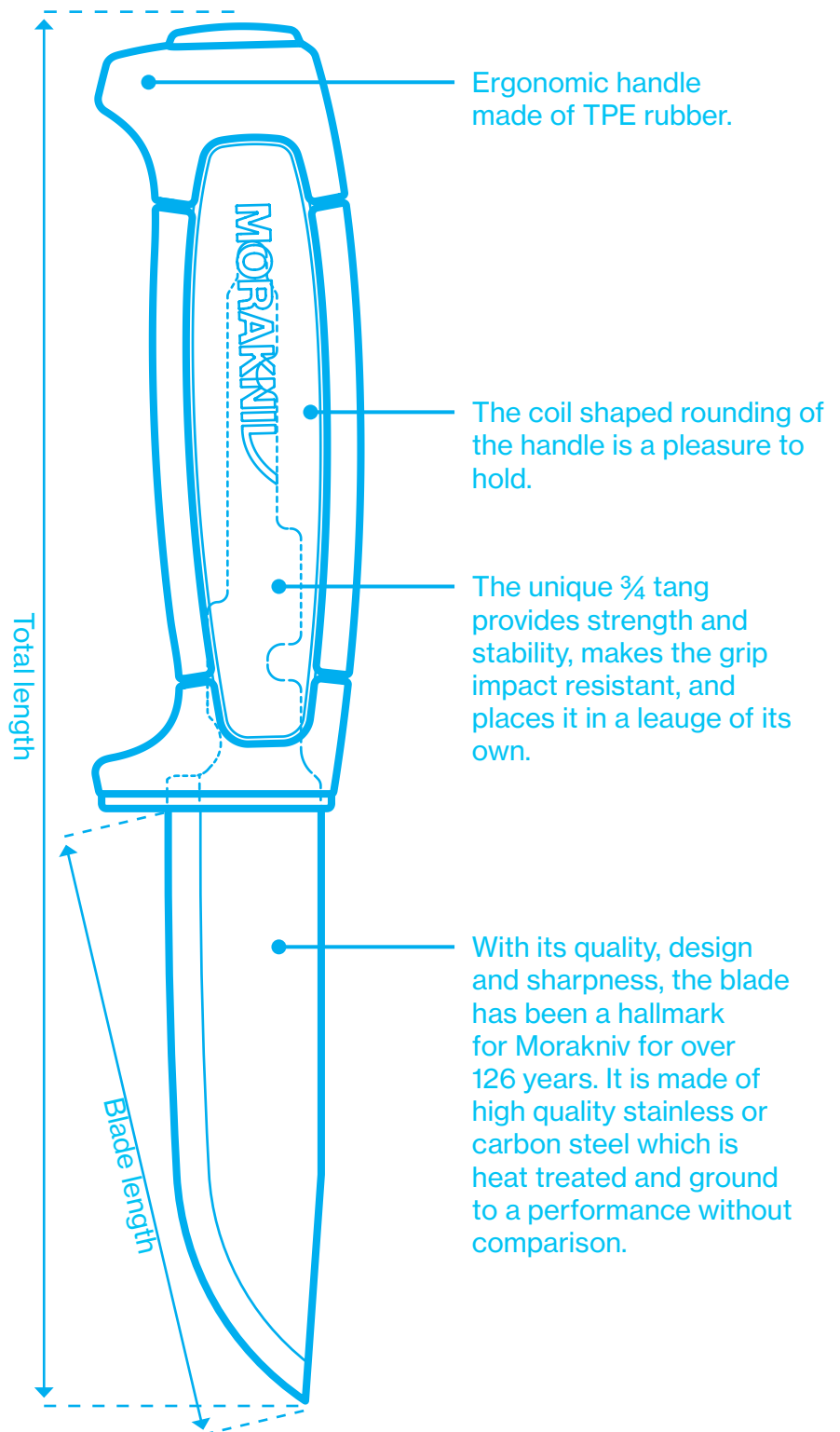

Morakniv Pro C

The blade is of high quality carbon steel that is easy to re-sharpen. Carbon steel can be affected by moisture and corrosive environments. Take therefore the habit of wiping off the knife and use oil on the blade after use.

Blade material:	Carbon steel
Blade thickness:	2,0 mm
Blade length:	91 mm
Knife length:	206 mm
Total length (sheath included):	224 mm
Item no. 15 pcs-display:	12243
Item no. 15 pcs-display sealed:	12431

Pro Series

This is the new generation of professional knives, made in Mora. In addition to the developed features for the basic knives we developed an ergonomic handle made of TPE rubber. It provides optimum grip friction. The coil shaped rounding of the handle is a pleasure to hold. The knife has a slightly larger blade, which can withstand higher loads and is made of knife steel which is also hardened in Mora, according to our SGM® (Steel Grade Mora) standard. The sheath comes with a smart button lock that makes it easy to attach or detach it to your workwear. A shield, showing the traditional Dalecarlian weapon, also gives you the possibility of linking several sheaths.



Morakniv Pro S

The blade is carefully selected stainless steel. Stainless steel stays sharp for a long time. It is the best choice when working in an outdoor environment. Black sheath with button lock.

Blade material:	Stainless Steel
Blade thickness:	2,0 mm
Blade length:	91 mm
Knife length:	206 mm
Total length (sheath included):	224 mm
Item No. 15 pcs-display:	12242
Item No. 15 pcs-display sealed:	12430



Morakniv Precision

Knife with short pointed blade ideal for all precision work from carving to remove burrs inside plastic pipes. The blade is made of carefully selected stainless steel that maintains its sharpness longer and can withstand a higher load on the blade. Black sheath with button lock.

Blade material:	Stainless Steel
Blade thickness:	2,0 mm
Blade length:	75 mm
Knife length:	191 mm
Total length (sheath included):	224 mm
Item No. 15 pcs-display:	12247
Item No. 15 pcs-display sealed:	12438



Morakniv Flex

Knife with a flexible blade for cable stripping, cutting rubber and silicone. Perfect to cut away the silicone joints in bathrooms and kitchens. The blade is made of carefully selected stainless steel that maintains its sharpness longer. Black sheath with button lock.

Blade material:	Stainless Steel
Blade thickness:	1,3 mm
Blade length:	88 mm
Knife length:	203 mm
Total length (sheath included):	224 mm
Item No. 15 pcs-display:	12248
Item No. 15 pcs-display sealed:	12439



Morakniv Chisel

Single side honed blade of carbon steel. The substantial and impact resistant handle makes this chisel knife the obvious tool for woodworking. Black sheath with button lock.

Blade material:	Chisel Steel
Blade thickness:	3,1 mm
Blade length:	75 mm
Knife length:	193 mm
Total length (sheath included):	224 mm
Item No. 15 pcs-display:	12250
Item No. 15 pcs-display sealed:	12440



Morakniv Rope

Serrated blade that has been developed for cutting rope, nylon and fiber. The stainless steel maintains sharpness longer and can withstand a higher load on the blade. Black sheath with button lock.

Blade material:	Stainless Steel
Blade thickness:	2,0 mm
Blade length:	91 mm
Knife length:	206 mm
Total length (sheath included):	224 mm
Item No. 15 pcs-display:	12245
Item No. 15 pcs-display sealed:	12441



Morakniv Robust

Robust knife with extra thick blade of carefully selected carbon steel and with an extra impact resistant handle. Black sheath with button lock.

Blade material:	Carbon Steel
Blade thickness:	3,2 mm
Blade length:	91 mm
Knife length:	206 mm
Total length (sheath included):	224 mm
Item No. 15 pcs-display:	12249
Item No. 15 pcs-display sealed:	12442



Morakniv Safe Pro

A sturdy knife with carbon steel blade. The blade has a rounded safety tip to prevent injuries and provide a safe practice. The ergonomically designed handle is impact resistant. Black sheath with button lock.

Blade material:	Carbon Steel
Blade thickness:	2,0 mm
Blade length:	82 mm
Knife length:	198 mm
Total length (sheath included):	224 mm
Item No. 15 pcs-display:	13076

[Check the Wranglerstar vlogs and learn all about how to use the Morakniv Chisel!](#)



See Video on YouTube

The sheaths have a smart button that makes it possible to connect and link several knives. This gives you the opportunity to carry your preferred combination of models.



Construction knives

Knives that have been developed in close collaboration with various professional categories within the construction industry. All specialty knives are ergonomically sound, efficient and safe to use.



1442 | Insulation knife
Blade of carbon steel. Suitable for cutting fabric covered mineral wool. The ample polymer handle fits your hand even when wearing gloves.

Blade material:	Carbon Steel
Blade thickness:	1 mm
Blade length:	300 mm
Total length:	450 mm
Item No. 10 pcs-bulk:	1-1442
Item No. 5 pcs PinPac:	11612



7350 | Insulation knife
Blade of stainless steel. For carving of mineral wool. The ample polymer handle fits your hand even when wearing gloves.

Blade material:	Stainless Steel
Blade thickness:	1,4 mm
Blade length:	350 mm
Total length:	500 mm
Item No. 10 pcs-bulk:	141-7230
Item No. 5 pcs PinPac:	11613



For both right- and left handed

Electrician's knife
Perfect knife for cable scaling. The blade has an integrated ergonomic finger guard that provides a safe handling and that prevents injuries. Blade of stainless steel.

Blade material:	Stainless Steel
Blade thickness:	1,4 mm
Blade length:	21 mm
Knife length:	154 mm
Total length (sheath included):	193 mm
Item No. 15 pcs-display:	12201



Carpet-/roofing felt-/leatherknife
Stainless steel blade. Oiled birchwood handle. The blade may be heated without it loosening from the handle. Polymer safety sheath.

Blade material:	Stainless Steel
Blade thickness:	2,0 mm
Blade length:	70 mm
Knife length:	190 mm
Total length (sheath included):	230 mm
Item No. 10 pcs-bulk:	13234



Carpet-/roofing felt-/leatherknife
Stainless steel blade. Plastic handle designed to give maximum pulling force. Polymer safety sheath.

Blade material:	Stainless Steel
Blade thickness:	2,0 mm
Blade length:	67 mm
Knife length:	185 mm
Total length (sheath included):	225 mm
Item No. 10 pcs-bulk:	13235



Service knife
The perfect choice when a standard craft blade is too long. The shorter blade without the traditional tip makes it safer and easier to use. The handle is covered with a friction grip.

Blade material:	Stainless Steel
Blade thickness:	2,0 mm
Blade length:	43 mm
Knife length:	160 mm
Total length (sheath included):	193 mm
Item No. 15 pcs-bulk:	12798



Allround knives

Morakniv Allround includes everything from ergonomically designed knives for professionals to simpler utility knives. No matter your preference, the knife you receive will maintain consistent, high-level quality, be sharp and have maximum edge lifetime.



Morakniv 711

Ergonomically designed handle, which facilitates work and prevents work-related and repetitive strain injuries. It's impact resistant, and has substantial finger protection. Blade of carbon steel. Black polymer sheath.

Blade material:	Carbon Steel
Blade thickness:	2,0 mm
Blade length:	102 mm
Knife length:	225 mm
Total length (sheath included):	244 mm
Item No. 15 pcs-display:	11481



Morakniv 746

Ergonomically designed handle, which facilitate work and prevents work-related and repetitive strain injuries. Impact resistant, and has substantial finger protection. Blade of stainless steel. Black polymer sheath.

Blade material:	Stainless Steel
Blade thickness:	2,0 mm
Blade length:	102 mm
Knife length:	225 mm
Total length (sheath included):	244 mm
Item No. 15 pcs-display:	11482



Morakniv 731

Ergonomically designed handle, which facilitate work and prevents work-related and repetitive strain injuries. Impact resistant, and has substantial finger protection. Blade of carbon steel. Black polymer sheath with a flexible leather strap.

Blade material:	Carbon Steel
Blade thickness:	2,5 mm
Blade length:	148 mm
Knife length:	275 mm
Total length (sheath included):	304 mm
Item No. 10 pcs-bulk:	1-0731



Morakniv 749

Ergonomically designed handle. Impact resistant, and has substantial finger protection. Blade of stainless steel. Black polymer sheath with a flexible leather strap.

Blade material:	Stainless Steel
Blade thickness:	2 mm
Blade length:	205 mm
Knife length:	330 mm
Total length (sheath included):	345 mm
Item No. 10 pcs-bulk:	1-0749



Classic

The Morakniv Classic knives are a true story. They are our tribute to the Swedish handicraft tradition that we have been part of for over a century. The Morakniv Classics are made of carbon steel which makes the knives easy to sharpen but requires more maintenance when exposed to moisture or corrosive environment. Make sure to keep the blade clean and dry.



Morakniv Classic No 1/0

This all-round knife is suitable for multiple purposes. Made of a birch wood handle, a high quality blade and a polymer sheath with leather belt strap.

Blade material:	Carbon Steel
Blade thickness:	2,0 mm
Blade length:	77 mm
Knife length:	170 mm
Total length (sheath included):	204 mm
Item No. 1pcs-package:	13603



Morakniv Classic No 2

This all-round knife is suitable for multiple purposes. Made of a birch wood handle, a high quality blade and a polymer sheath with leather belt strap.

Blade material:	Carbon Steel
Blade thickness:	2,5 mm
Blade length:	105 mm
Knife length:	214 mm
Total length (sheath included):	250 mm
Item No. 1pcs-package:	13604



Morakniv Classic No 3

This all-round knife is suitable for multiple purposes. Made of a birch wood handle, a high quality blade and a polymer sheath with leather belt strap.

Blade material:	Carbon Steel
Blade thickness:	2,5 mm
Blade length:	135 mm
Knife length:	253 mm
Total length (sheath included):	292 mm
Item No. 1pcs-package:	13605



Morakniv Classic No 2F

A true Classic knife with protective finger guard, granting extra safety while working with the knife. Made of a birch wood handle, a high quality blade and a polymer sheath with leather belt strap.

Blade material:	Carbon Steel
Blade thickness:	2,5 mm
Blade length:	105 mm
Knife length:	216 mm
Total length (sheath included):	250 mm
Item No. 1pcs-package:	13606



Morakniv Classic Wood Splitting Knife

Made of a birch wood handle and a high quality blade. This Classic knife is made for splitting wood into kindling, to help you start a fire.

Blade material:	Carbon Steel
Blade thickness:	2,5 mm
Blade length:	115 mm
Total length:	363 mm
Item No. 1pcs-package:	13607

Morakniv Classic Original

This is what a real Morakniv looked like before it received its characteristic red handle. Originally the handles were made of oiled birch wood and the knives had leather sheaths.



Morakniv Classic Original 1 Exclusive

The oiled birch wood handle gives a natural feel. The knife's laminated steel blade provides it with unsurpassable toughness and superior edge resiliency. Classic sheath of natural leather.

Blade material:	Laminated Carbon Steel
Blade thickness:	-2,7 mm
Blade length:	99 mm
Knife length:	195 mm
Total length (sheath included):	214 mm
Item No. 1 pcs-box:	11934



Morakniv Wood Splitting Knife 220

Use the wood splitting knife to make smaller pieces of wood for starting the fire. It has a carbon steel blade and a double handle made of birch wood, making it effective and simple to work with.

Blade material:	Carbon Steel
Blade thickness:	2,5 mm
Blade length:	114 mm
Total length:	366 mm
Item No. 10 pcs-bulk:	11729
Item No. 12 pcs 1-package:	12039

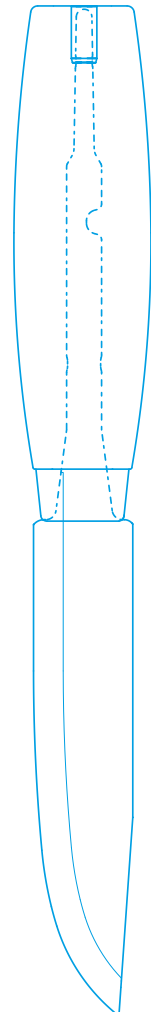

A true story

The Morakniv Classic carbon knife with the characteristic barrel-shaped and red-stained birch handle was first introduced around one hundred years ago with the ambition to portray an exclusive mahogany knife. In the decades since, it has grown into one of the most beloved lifestyle knives in the world – a timeless Morakniv in its purest form. Generations of woodcarvers, carpenters and craftsmen have been using, personalizing and improving the Classic knives ever since.

Like the original knife, the new Morakniv Classic collection also features a shimmering transparent red-stained birch handle that highlights the wood grain. In other words, each knife is truly unique. The polymer sheath with a polished look is covered with the Dalecarlian shield and has a belt strap of Swedish vegetable tanned leather, designed to stand the test of time for generations to come.



The red handle, one of the main characteristics of Morakniv, was at first a way to make the knives look more exclusive. Originally, the more valuable knives were made from curly birch. But when the curly birch became a scarce commodity, regular birch had to be used. And to retain the production of exclusive knives, the birch handles were painted red so that they would look just like mahogany.





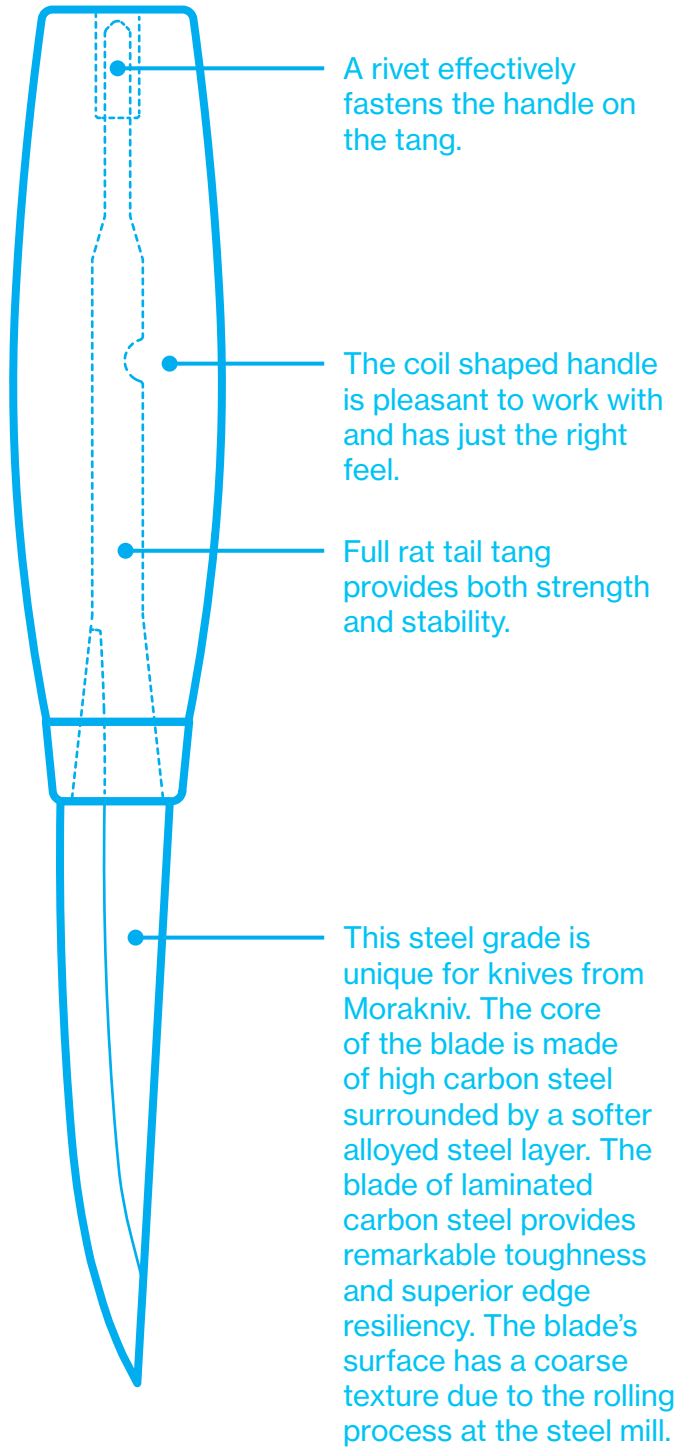

Wood carving 106

Wood carving 106 has a pointed knife blade made of laminated carbon steel, which gives it superior toughness and edge resiliency. The barrel shaped handle made of oiled birch wood is slightly larger for a proper grip.

Blade material:	Laminated Carbon Steel
Blade thickness:	~2,7 mm
Blade length:	82 mm
Total length:	190 mm
Item No. 10 pcs-bulk:	106-1630
Item No. 5 pcs PinPac:	106-1632

Wood carving knives

The most important thing when it comes to wood carving is a sharp knife, there's no avoiding that fact. Instead of being a wonderful, creative experience, it can become both irritating and dangerous if the knife is blunt. A real sharp knife gets you on the right path quite simply.

Our knives are well known for their quality and precision, appreciated by generations of craftspeople. They're even used by the skilled craftspeople in Nusnäs where they carve one of our most well known Swedish symbols, the Dala horse.



Morakniv Wood carving 120

Wood carving knife with a thin, tapered blade of laminated carbon steel. Oiled birchwood handle, polymer sheath.

Blade material:	Laminated Carbon steel
Blade thickness:	~2,7 mm
Blade length:	82 mm
Knife length:	190 mm
Total length (sheath included):	230 mm
Item no. 10 pcs-bulk:	106-1630
Item no. 1 pcs-PinPac 5/ctn:	106-1632



Morakniv Wood carving 105

Large wood carving knife with a thin, tapered blade of laminated carbon steel. Oiled birchwood handle. Delivered with a simple edge protection.

Blade material:	Laminated Carbon steel
Blade thickness:	~2,7 mm
Blade length:	79 mm
Knife length:	200 mm
Total length (sheath included):	213 mm
Item no. 10 pcs-bulk:	106-1650



Morakniv Wood carving 122

Wood carving knife with a thin, tapered blade of laminated carbon steel for chip carving. Oiled birchwood handle, polymer sheath.

Blade material:	Laminated Carbon steel
Blade thickness:	~2,7 mm
Blade length:	59 mm
Knife length:	170 mm
Total length (sheath included):	230 mm
Item no. 10 pcs-bulk:	106-1654



Morakniv Wood carving 106

Wood carving knife with a thin, tapered blade of laminated carbon steel. Oiled birchwood handle, polymer sheath.

Blade material:	Laminated Carbon steel
Blade thickness:	~2,7 mm
Blade length:	82 mm
Knife length:	190 mm
Total length (sheath included):	230 mm
Item no. 10 pcs-bulk:	106-1630
Item no. 1 pcs-PinPac 5/ctn:	106-1632



Morakniv Wood carving Basic

Wood carving knives with a thin, tapered blade of stainless steel. Polymer handle, polymer sheath.

Blade material:	Stainless steel
Blade thickness:	2,0 mm
Blade length:	75 mm
Knife length:	186 mm
Total length (sheath included):	235 mm
Item no. 15 pcs-bulk:	12658



Morakniv Wood carving kit

Our wood carving kit includes a classic wood carving knife no 120 and a wooden Dala horse to work on. It's a given combination of two of Sweden's most famous national symbols.

Item No. 5 pcs-ctn:	12670
---------------------	-------



Chopstick carving kit

Our Chopstick carving kit includes a classic wood carving knife no 120 and four pieces of wood for making chop sticks.

Item No. 12 pcs-ctn:	13275
----------------------	-------





Hook knives

The most important thing when it comes to wood carving is a sharp knife. Instead of being a wonderful, creative experience, it can become both irritating and dangerous if the knife is blunt. A real sharp knife gets you on the right path quite simply.

If you want to carve your own spoon, bowl or cup, you will need a hook knife as its U-shape makes it possible to hollow out rounded and concave shapes.

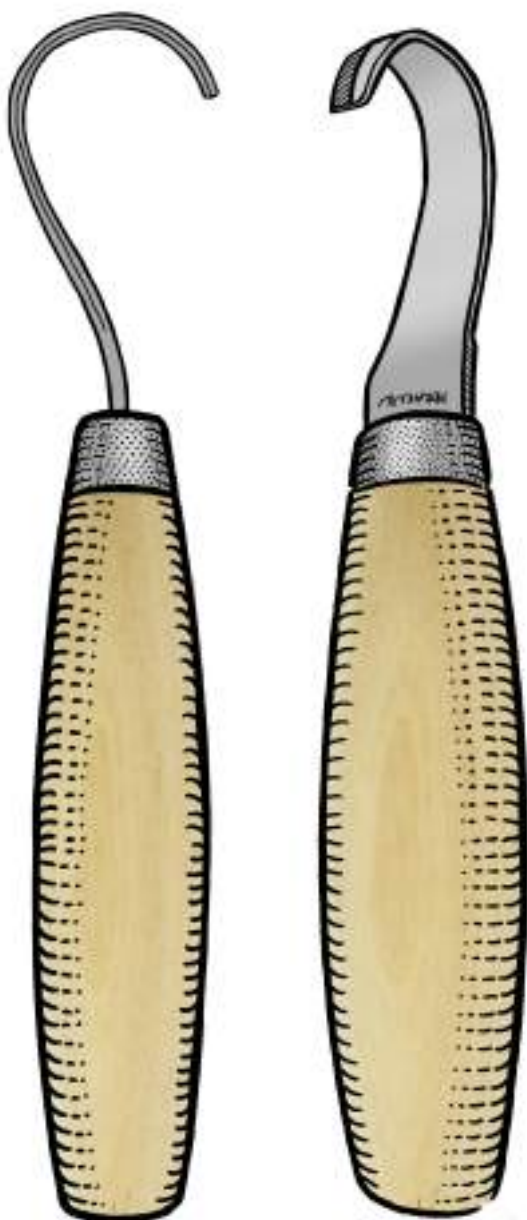

Safer to use

To improve safety when carving, the knives have a rounded safety tip to take away the biggest cause of injuries.

The Handle

The classic Morakniv shaped handle made out of birch wood sits perfectly in your hand independent of grip or carving technique. Natural wood also gives excellent friction and feeling against your skin. A wooden handle also gives the possibility to reshape the handle according to own preferences.

The edge protection

To protect both you and the knife our hook knives comes with or without a simple but ingeniously designed leather edge protection made out of Swedish vegetable tanned leather manufactured locally with cowhides from the region.

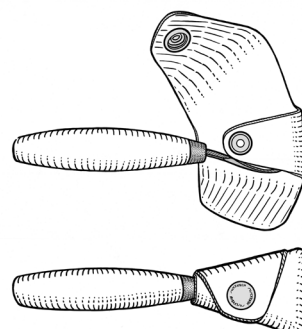

The blade

The blade has to run through the curve you are carving in the wood, and if it is wide front to back - the back edge catches on the inside of the curve and makes the edge dig in, this results in chatter rather than a smooth cut.

Therefore we've optimized the blade to make it run smooth over the inside of the spoon or bowl. Improved edge bevels complete the blade and give it the optimum carving experience.

All hook knife blades are made of stainless steel.

Smoother Cuts

The blade has been optimized to make it run smooth over the inside of the spoon or bowl.

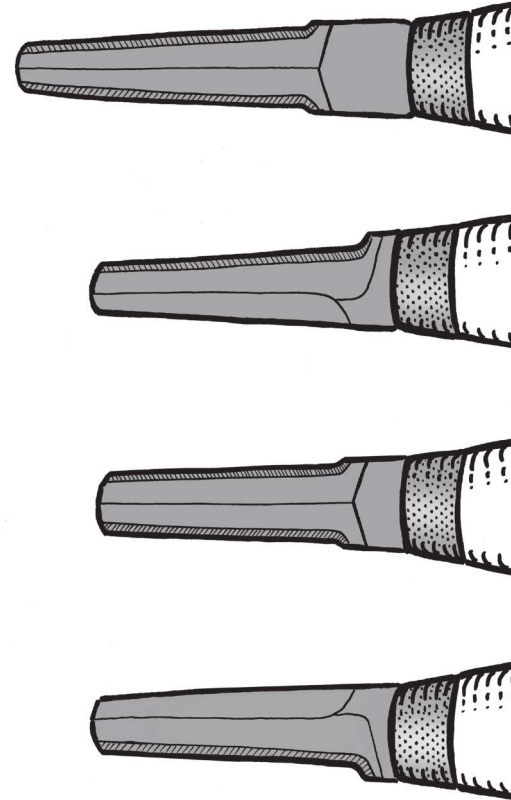
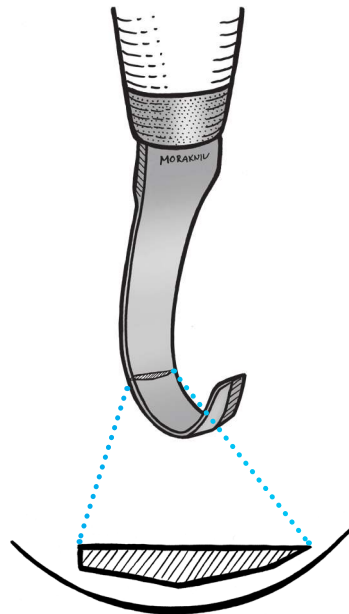

How to carv a spoon

See how our ambassador Jögge Sundqvist, or surolle as he's known, is carving a spoon in the Swedish Knife Grip Sessions shown on our YouTube channel.



See Video on
YouTube



Our Hook knives

The blade on our hook knives comes in four different versions. Large and small radius, Double edges for both push and pull carving and single edge for left or right hand. All with space for finger support along the spine.



Knife 164

Left Handed

This knife has a single-edged stainless steel blade for left hand use. The back of the knife is not sharp which gives you the possibilities to use your right hand to push the blade with your fingers from the back. This blade has the smaller curve of our hook knives.

The knife comes with an edge protection made out of vegetable tanned leather, from Sweden.

Item No 13386



Hook Knife 164

Right Handed

This knife has a single-edged stainless steel blade for right hand use. The back of the knife is not sharp which gives you the possibility to use your left hand to push the blade with your fingers from the back. This blade has the smaller curve of our hook knives.

The knife comes with an edge protection made out of vegetable tanned leather, from Sweden.

Item No 13385

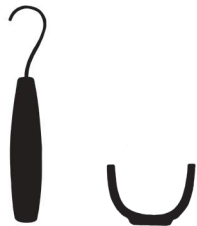

Hook Knife 162

Double edge

This knife has a double-edged stainless steel blade so that you can use it for both pull and push carving. The blade has the smaller curve of our hook knives.

The knife comes with an edge protection made out of vegetable tanned leather, from Sweden.

Item No 13388



Hook Knife 163

Double edge

A knife with a double-edged stainless steel blade, for both pull and push carving. This blade has a more open curve. Perfect for making a clean cut surface or bowls with large radius.

The knife comes with an edge protection made out of vegetable tanned leather, from Sweden.

Item No 13387

Hook knives and edge protection



Morakniv Hook knife 164 Left Handed

Updated Hook knife with left edged blade made for spoon carving. Oiled birchwood handle. 13 mm radius. Narrow curve.

Blade material:	Stainless Steel
Blade thickness:	2,0 mm
Blade length:	55 mm
Knife length:	164 mm
Total length (sheath included):	170 mm
Item No. 10 pcs-bulk:	13444
Without Edge Protection	
Item No. 1 pcs box/5 ctn:	13386
With Edge Protection	



Morakniv Hook knife 164 Right Handed

Updated Hook knife with right edged blade made for spoon carving. Oiled birchwood handle. 13 mm radius. Narrow curve.

Blade material:	Stainless Steel
Blade thickness:	2,0 mm
Blade length:	55 mm
Knife length:	164 mm
Total length (sheath included):	170 mm
Item No. 10 pcs-bulk:	13443
Without Edge Protection	
Item No. 1 pcs box/5 ctn:	13385
With Edge Protection	



Morakniv Hook knife 162 Double Edge

Updated Hook knife with double edged blade made for spoon carving. Oiled birchwood handle. 13 mm radius. Narrow curve.

Blade material:	Stainless Steel
Blade thickness:	2,0mm
Blade length:	55 mm
Knife length:	164 mm
Total length (sheath included):	170 mm
Item No. 10 pcs-bulk:	13446
Without Edge Protection	
Item No. 1 pcs box/5 ctn:	13388
With Edge Protection	



Morakniv Hook knife 163 Double Edge

Updated Hook knife with double edged blade made for spoon carving. Oiled birchwood handle. 24 mm radius. Wide curve.

Blade material:	Stainless Steel
Blade thickness:	2,0 mm
Blade length:	74 mm
Knife length:	183 mm
Total length (sheath included):	190 mm
Item No. 10 pcs-bulk:	13445
Without Edge Protection	
Item No. 1 pcs box/5 ctn:	13387
With Edge Protection	



Edge protection for Morakniv Hook knife 163

Edge protection for Morakniv Hook knife 163 double edged blade. Made of Swedish vegetable tanned leather with button lock. **Only fits Hook Knives manufactured year 2019 or later.** For wide curve (R24).

1 pcs box/10ctn:	13468
------------------	-------



Edge protection for Morakniv Hook knives 162 & 164

Edge protection for Morakniv Hook knives 162 left and right handed as well as Morakniv Hook knife 164. Made of Swedish vegetable tanned leather with button lock. **Only fits Hook Knives manufactured year 2019 or later.** For narrow curve (R13).

1 pcs box/10ctn:	13469
------------------	-------





Knife blade blanks

Have you ever wanted to make your own knife? Our pre-shaped Morakniv blades make your knife making project easy. Hardened, tempered and with different steel qualities, ready for you to create a handle. We have several blade blanks of different steel types: stainless, carbon and laminated. Release your creativity and choose your favorite handle material: masur birch, walnut, elm, horn. The only limitation is your imagination!



Morakniv Knife blade No. 98 | Fish scaler
Blade of stainless steel. Tang length 70 mm.

Blade material:	Stainless Steel
Blade thickness:	2,0 mm
Blade length:	117 mm
Total length:	185 mm
Item No. 20 pcs PinPac:	191-2338

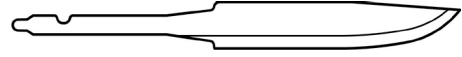

Morakniv Knife blade No. 1 | Stainless
3/4 rat tail tang with blade of high quality stainless steel.

Blade material:	Stainless Steel
Blade thickness:	2,0 mm
Blade length:	99 mm
Total length:	178 mm
Item No. 25 pcs PinPac:	191-2334



Morakniv Knife blade No. 120
Full rat tail tang with blade of laminated carbon steel.

Blade material:	Laminated Carbon Steel
Blade thickness:	2,7 mm
Blade length:	62 mm
Total length:	168 mm
Item No. 20 pcs PinPac:	191-2603



Morakniv Knife blade No. 3 | Carbon
Full rat tail tang with blade of carbon steel.

Blade material:	Carbon Steel
Blade thickness:	2,5mm
Blade length:	135 mm
Total length:	251 mm
Item No. 20 pcs PinPac:	13736



Morakniv Knife blade No. 106 | Laminated
Full rat tail tang with blade of laminated carbon steel.

Blade material:	Laminated Carbon Steel
Blade thickness:	2,7 mm
Blade length:	85 mm
Total length:	192 mm
Item No. 20 pcs PinPac:	191-2423

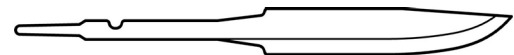

Morakniv Knife blade No. 1 | Laminated
Full rat tail tang with blade of laminated carbon steel.

Blade material:	Laminated Carbon Steel
Blade thickness:	2,7 mm
Blade length:	100 mm
Total length:	199 mm
Item No. 20 pcs PinPac:	191-2333



Morakniv Knife Blade No. 2000
3/4 push tang with blade of stainless steel.

Blade material:	Stainless Steel
Blade thickness:	2,5 mm
Blade length:	113 mm
Total length:	190 mm
Item No. 20 pcs PinPac:	191-25062



Morakniv Knife blade No. 1/0 | Carbon
Full rat tail tang with blade of carbon steel.

Blade material:	Laminated Carbon Steel
Blade thickness:	2 mm
Blade length:	77 mm
Total length:	169 mm
Item No. 20 pcs PinPac:	13735

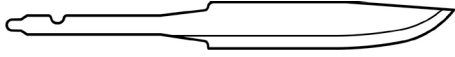

Morakniv Knife blade No. 1 | Carbon

3/4 rat tail tang with blade of high carbon steel.

Blade material:	Carbon Steel
Blade thickness:	2,0 mm
Blade length:	99 mm
Total length:	178 mm
Item No. 25 pcs PinPac:	12002



Morakniv Knife blade No. 2 | Carbon

3/4 rat tail tang with blade of high carbon steel.

Blade material:	Carbon Steel
Blade thickness:	2,5 mm
Blade length:	105 mm
Total length:	213 mm
Item No. 20 pcs PinPac:	13734









Morakniv® Kitchen

A part of your kitchen life

It's all about the details. The feeling when your knife fits comfortably in your hand, the weight of the handle, the movement of the blade back and forth on the chopping board. And we thought about all that when we designed our kitchen knives. Because cooking is so much simpler and more fun when you have that special feeling and great tools.

We have a kitchen knife to suit every moment in the kitchen. The Classic 1891 range, inspired by our region of Dalarna, includes a peeling knife to help you sort out onions, fruit and vegetables, and the chef's knife for bigger tasks. There's also the bread knife to slice your sandwiches, the fillet knife for your fish soup, and the all-round knife for, well, all the rest. Your Morakniv knife is always there with you, both for the every day meals and the special occasions.



Johan knows a good knife

Johan Jureskog is one of our most dedicated top chefs in Sweden. When it comes to preparing food it's clear; everything has to be perfect. The ingredients, kitchen tools, and presentation must be of the highest quality. There's no doubt that his strong drive and level of perfection has delivered great results.

During his eight years in the Swedish national culinary team, he added gold medals in cooking from both the Olympic Games and World Championships to his merit list. He's also won several prestigious prizes by himself, such as the Gastronomic Academy's gold medal. Johan runs the top Stockholm restaurants Rolfs Kök and AG, the latter awarded Sweden's best meat restaurant for three years in a row. He has also written cookbooks and can often be seen on TV where he shares his best recipes, which most often focus on meat.

Johan has worked with Morakniv to create the kitchen knives in our Classic 1891 range. After many years in the international restaurant industry he knows that good knives are critical to success in the kitchen. That's why Morakniv was his obvious choice and why he joined us on the journey to create the ultimate kitchen knives.

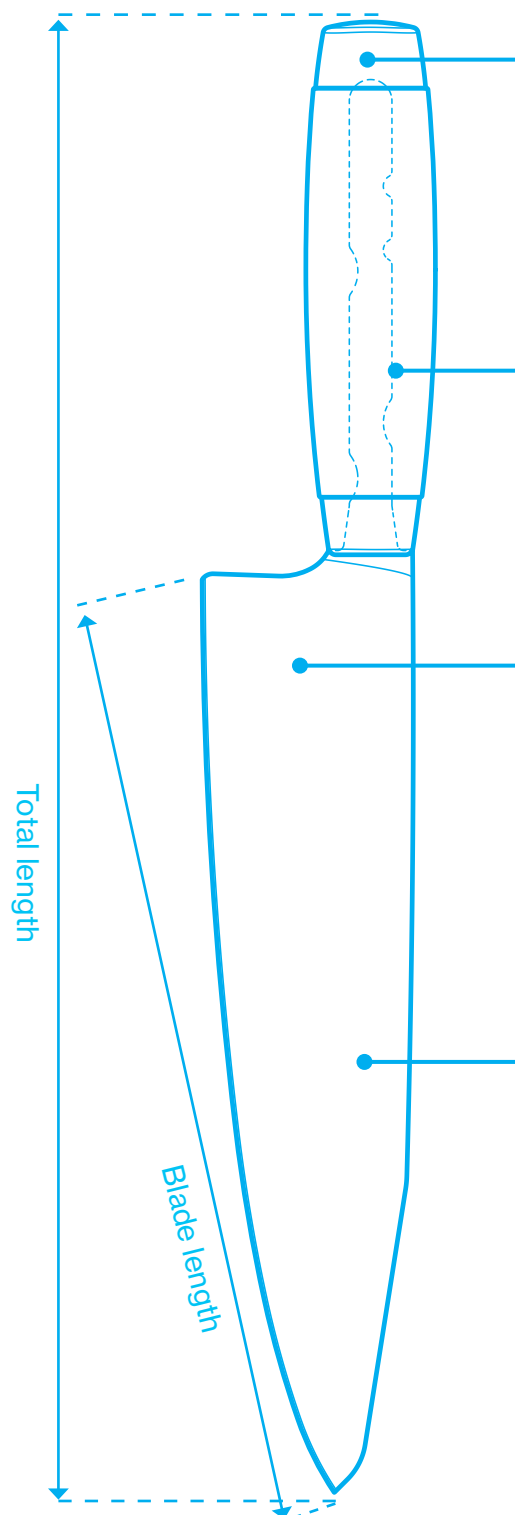

Ferrules with Dalarna's coat of arms

The ferrules are made of precision cast stainless steel which gives the knife a rustic look and creates a comfortable weight and balance. Dalarna's coat of arms, which has always been one of the main characteristics of Morakniv, is embossed in the back. It stands as a guarantee of quality and craftsmanship.

The handle

The handle consists of red or black stained Swedish birch and has a barrel shape. It's related to our classic knives, but with the shape adapted to kitchen use. This provides improved ergonomics and a more stable grip, making your time in the kitchen more enjoyable.

The finger guard

Morakniv is a locally owned family business that takes pride in administering such a strong and popular symbol of Mora and Sweden. Sustainability and responsibility are living parts of our culture. Therefore, it is natural for us to manufacture safe and secure products. With that in mind, we have developed a finger protection that is specifically designed to fit the knife function and size.

The blade

We use stainless Swedish steel 14C28N. The steel is hardened and tempered to 58 HRC according to our SGM® (Steel Grade Mora) standard that gives each knife the optimal combination of features for its intended use. The knife edge bevels are ground on both sides of the blade to 18°, giving a total edge angle of 36°. The blade has a tapered profile typical for all Morakniv knives. Together with the rounded tip of the blade, this makes the knife harmonious, balanced and safe to use. The blade is polished following the classical food processing tradition, where a polished blade is a requirement in the regulations for hygiene standards.

Color

The dark red color was initially introduced to make the birch mimic the more upmarket mahogany. Today the red wooden handle has developed its own identity which is symbolic of Sweden. In addition to this signature color, we have also created a black series in which our tradition of craftsmanship interacts with a more modern Scandinavian design profile.

Classic 1891



Chef's Knife Classic 1891 : Red

The primary general-utility knife for your kitchen. A knife with excellent balance that feels like an extension of your hand. The blade has an integrated finger stop and offers razor sharp performance. The slightly rounded tip allows safe handling and prevents injuries. The handle, coated with a red-dish stain, is contoured for comfort.

Blade material:	Stainless Steel
Blade thickness:	2,5mm
Blade length:	220 mm
Knife length:	345 mm
Total length:	345 mm
Item No. 1 pcs-box:	12309



Bread Knife Classic 1891 : Red

This beautiful knife is ergonomically designed to prevent your knuckles from hitting the chopping board. The long blade has a progressive curved edge which makes it easy to slice cleanly through the crispy crusts of whole loaves. It can also be used for carving meat or chopping vegetables.

Blade material:	Stainless Steel
Blade thickness:	2,5 mm
Blade length:	246 mm
Knife length:	371 mm
Total length:	371 mm
Item No. 1 pcs-box:	12310



Fillet Knife Classic 1891 : Red

The fillet knife has a blade which is increasingly flexible towards the tip to ensure smooth filleting. The knife is suitable for most fish sizes, and can also be used for trimming meat. The blade has an integrated finger guard.

Blade material:	Stainless Steel
Blade thickness:	2,5 mm
Blade length:	188 mm
Knife length:	313 mm
Total length:	313 mm
Item No. 1 pcs-box:	12311



Utility Knife Classic 1891 : Red

The utility knife has a convenient blade with an integrated finger stop and slightly rounded tip that ensures safe handling. The knife has been developed for cutting onions and other vegetables but is also suitable as a child's knife. Just be aware of its sharpness!

Blade material:	Stainless Steel
Blade thickness:	2,0 mm
Blade length:	128 mm
Knife length:	233 mm
Total length:	233 mm
Item No. 1 pcs-box:	12313



Paring Knife Classic 1891

The Paring Knife is a great help in the kitchen and can be used in a wide variety of ways like peeling fruits and vegetables, slicing, trimming and dicing. The slightly larger handle provides a good steady grip.

Blade material:	Stainless Steel
Blade thickness:	2,0 mm
Blade length:	85 mm
Knife length:	190 mm
Total length:	190 mm
Item No. 1 pcs-box:	12312



Knife Set Classic 1891 : Red

Get ready for all kinds of kitchen tasks with the knife set including our Chef's Knife, Bread Knife, and Paring Knife. With these knives you are prepared for general-utility work as well as finer tasks such as trimming, peeling and dicing.

Blade material:	Stainless Steel
Blade thickness:	2,5 / 2,5 / 2,0 mm
Blade length:	222 / 246 / 85 mm
Blade length:	222/246/85 mm
Total length:	345/246/190 mm
Item No. 1 set-box :	12422







Chef's Knife Classic 1891 : Black

A primary general-utility knife for most cooks. A knife with excellent balance and a beautiful black birchwood handle that provides a smooth, comfortable grip. The blade has an integrated finger stop. The beveled tip allows safe handling and prevents injuries. A pleasure to use for all-purpose chopping, slicing, dicing and mincing.

Blade material:	Stainless Steel
Blade thickness:	2,5mm
Blade length:	220 mm
Knife length:	345 mm
Total length:	345 mm
Item No. 1 pcs-box:	12314



Bread Knife Classic 1891 : Black

The bread knife is ergonomically designed to prevent your knuckles from hitting the chopping board. It has a progressive curved edge which makes it easy to slice cleanly through even large crusty loaves without mashing the soft interior. It can also be used for carving meat or chopping vegetables.

Blade material:	Stainless Steel
Blade thickness:	2,5 mm
Blade length:	246 mm
Knife length:	371 mm
Total length:	371 mm
Item No. 1 pcs-box:	12315



Fillet Knife Classic 1891 : Black

The fillet knife is increasingly flexible towards the tip to ensure smooth filleting. The knife is suitable for most fish sizes, and can also be used for trimming meat. The blade has an integrated finger guard.

Blade material:	Stainless Steel
Blade thickness:	2,5 mm
Blade length:	188 mm
Knife length:	313 mm
Total length:	313 mm
Item No. 1 pcs-box:	12316



Utility Knife Classic 1891 : Black

The utility knife has a convenient blade with an integrated finger stop and slightly rounded tip that ensures safe handling. The knife has been developed for cutting onions and other vegetables but is also suitable as a child's knife. Just be aware of its sharpness!

Blade material:	Stainless Steel
Blade thickness:	2,0 mm
Blade length:	128 mm
Knife length:	233 mm
Total length:	233 mm
Item No. 1 pcs-box:	12318



Paring Knife Classic 1891 : Black

The paring knife is perfect for tasks that require more finesse, such as peeling fruits and mincing vegetables. The slightly larger handle provides a good and steady grip. Use it for everything from prepping produce to slicing sandwiches.

Blade material:	Stainless Steel
Blade thickness:	2,0 mm
Blade length:	85 mm
Knife length:	190 mm
Total length:	190 mm
Item No. 1 pcs-box:	12317



Knife Set Classic 1891 : Black

Get ready for all kinds of kitchen tasks with the knife set including our Chef's Knife, Bread Knife, and Paring Knife. With these knives you are prepared for general-utility work as well as finer tasks such as trimming, peeling and dicing.

Blade material:	Stainless Steel
Blade thickness:	2,5 / 2,5 / 2,0 mm
Blade length:	222 / 246 / 85 mm
Knife length:	345/246/190 mm
Total length:	345/246/190 mm
Item No. 1 set-box :	12423



Kitchen Accessories

Add that extra something to your kitchen! Sharp knives are key to a good kitchen experience. And so are the finishing touches, like a matching sharpening steel or carving fork, or why not a luxurious hand made leather apron.



Sharpening Steel Classic 1891: Red

A good sharpening steel is almost as important as the knife itself. This is a smooth polishing steel which will give the knife edge maximum sharpness by aligning the edge. There is a coarser side on the steel that is used for grinding when the edge is worn down.

Steel length:	245mm
Total length:	369mm
Item No. 1 pcs-box:	12448



Sharpening Steel Classic 1891: Black

A good sharpening steel is almost as important as the knife itself. This is a smooth polishing steel which will give the knife edge maximum sharpness by aligning the edge. There is a coarser side on the steel that is used for grinding when the edge is worn down.

Steel length:	245 mm
Total length:	369 mm
Item No. 1 pcs-box:	12449



Carving Fork Classic 1891: Red

Hold the roast or turkey in place while carving or use the fork to flip the steak while cooking. The fork and the Chef's knife creates a perfect match and a given combination for carving. The fork is handmade and has the same beautiful handle as the rest of the knives in the kitchen series. An effective and handsome tool for any home or professional chef.

Blade material:	Stainless Steel
Blade thickness:	2,5 mm
Blade length:	150 mm
Total length:	270 mm
Item No. 1 pcs-box:	12598



Carving Fork Classic 1891: Black

Hold the roast or turkey in place while carving or use the fork to flip the steak while cooking. The fork and the Chef's knife creates a perfect match and a given combination for carving. The fork is handmade and has the same beautiful handle as the rest of the knives in the kitchen series. An effective and handsome tool for any home or professional chef.

Blade material:	Stainless Steel
Blade thickness:	2,5 mm
Blade length:	150 mm
Total length:	270 mm
Item No. 1 pcs-box:	12803





Steak Knives

A Morakniv is designed to feel like an extension of your hand, as it is easy to hold and to handle. Our exclusive steak knives are no exception. Here we combine centuries of tradition with new design. They have the look and feel of a traditional Morakniv to create elegant, high performance steak knives.



Morakniv Steak Knife

A knife with striking beauty for an enhanced dining experience at home and a must for every dining table. The blade of our steak knife is made from high quality stainless steel that, after hardening, has an excellent sharpness retention. The blade is heat treated to make it outstandingly strong and maximise the lifetime of its edge. The knife edge bevels are ground on both sides of the blade to 17°, giving a total edge angle of 34°. The handle is made from carefully selected curly birch. Design: Märten Cyrén and Mathias Dahlgren.

Blade material:	Stainless Steel
Blade thickness:	2,5 mm
Blade length:	122 mm
Knife length:	225mm
Total length:	225 mm
Item No. 2pcs-box:	11460



Morakniv Steak Knife Classic

The perfect partner when dining on a tender steak, either at home or in a restaurant. We made as few changes as possible to our original knives to retain Steak Knife Classic's identity and tradition. The blade of our steak knife is made from high quality stainless steel which we harden to 58 HRC. The blade is heat treated to make it outstandingly strong and maximise the lifetime of its edge. The knife edge bevels are ground on both sides of the blade to 11,5°, giving a total edge angle of 23°. The handle is made from red painted birch.

Blade material:	Stainless Steel
Blade thickness:	2 mm
Blade length:	106 mm
Knife length:	205mm
Total length:	205 mm
Item No. 2pcs-box:	12160

MORAKNIL®



MORAKNIF

MADE IN SWEDEN STAINLESS



Made in Sweden

MORAKNIF



MORAKNIF



Packaging solutions



1. Knife Set Classic 1891 | 1 pcs box/3-box set 2. Classic 1891 | 1-pcs box 3. Steak knife | 2-pcs box 4. Morakniv Eldris | 1 pcs box/15-pcs display 5. Morakniv 511 basic, sealed | 15-pcs display 6. Craft Pro | 15-pcs display 7. PinPac 8. Morakniv Basic 511 | 40-pcs bucket 9. Morakniv wood carving 120 | 10-pcs bulk 10. Morakniv knife blade | 1-pcs PinPac 11. Hook knife 162 | 1-pcs box 12. Morakniv Expert SRT | 1-pcs box.



Frosts[®]

A professional part of Morakniv

We manufacture all our knives using a combination of craftsmen skills and modern technology. Design, material and methods are all constantly refined by staff who have inherited generations of professional knowledge. This can be seen in our long tradition of making top quality knives for the food industry.

We have a wide range for hoof care, as well as a complete range of food industry knives for professionals, both of which we manufacture under the brand Frosts.

The consistent, high-level quality of our knives enables users to receive a great deal of benefit and joy from them over a long period of time. Their long lifetime is a strong contributing factor for Frosts knives, providing very positive overall economics – they always win in the end. This way your Frosts knife becomes a natural part of your profession and your workday.

Frosts[®]
MORA





Frosts Hoof Product Line

We offer a complete range of Hoof Trimming knives for demanding professionals.

Everything, from the steel for the blades and material for the handles, is carefully selected for high quality and user benefits. We work closely together with active professionals who give their input to how we can make our products as good and useful as possible.

In addition to the great variety, some of the knives can be used by both left- and right-handed. In other words, each and every farrier can find their new favorite tool right here. We have something for everyone.

Frosts Hoof Trimming knives

Our hoof trimming knives are developed in close collaboration with farriers and veterinarians. This makes them fully equipped for the demands of working with hoofs. All our knives are available for both left- and right-handed use and the handles fit the hand perfectly. Together with the high quality steel of the blade, the knives are all efficient, easy to work with and can be easily honed.



Frosts Hoof 171 Narrow

Hoof Trimming knife with a blade of cold-rolled special stainless steel. Birchwood handle. Available for both left- and right-handed use.

Blade material:	Stainless Steel
Blade thickness:	2,5 mm
Blade length:	71 mm
Total length:	203 mm
Item No. 10-pcs/box Left handed:	109-1910
Item No. 10-pcs/box Right handed:	109-1920



Frosts Hoof 180 Wide

Hoof Trimming knife with a blade of cold-rolled special stainless steel. Birchwood handle. Available for both left- and right-handed use.

Blade material:	Stainless Steel
Blade thickness:	2,5 mm
Blade length:	80 mm
Total length:	206 mm
Item No. 10-pcs/box Left handed:	109-1930
Item No. 10-pcs/box Right handed:	109-1940



Frosts Hoof 188 Double-Edge

Double-edged blade of cold-rolled special stainless steel. Birchwood handle.

Blade material:	Stainless Steel
Blade thickness:	2,5 mm
Blade length:	80 mm
Total length:	206 mm
Item No. 10-pcs/box:	109-1950

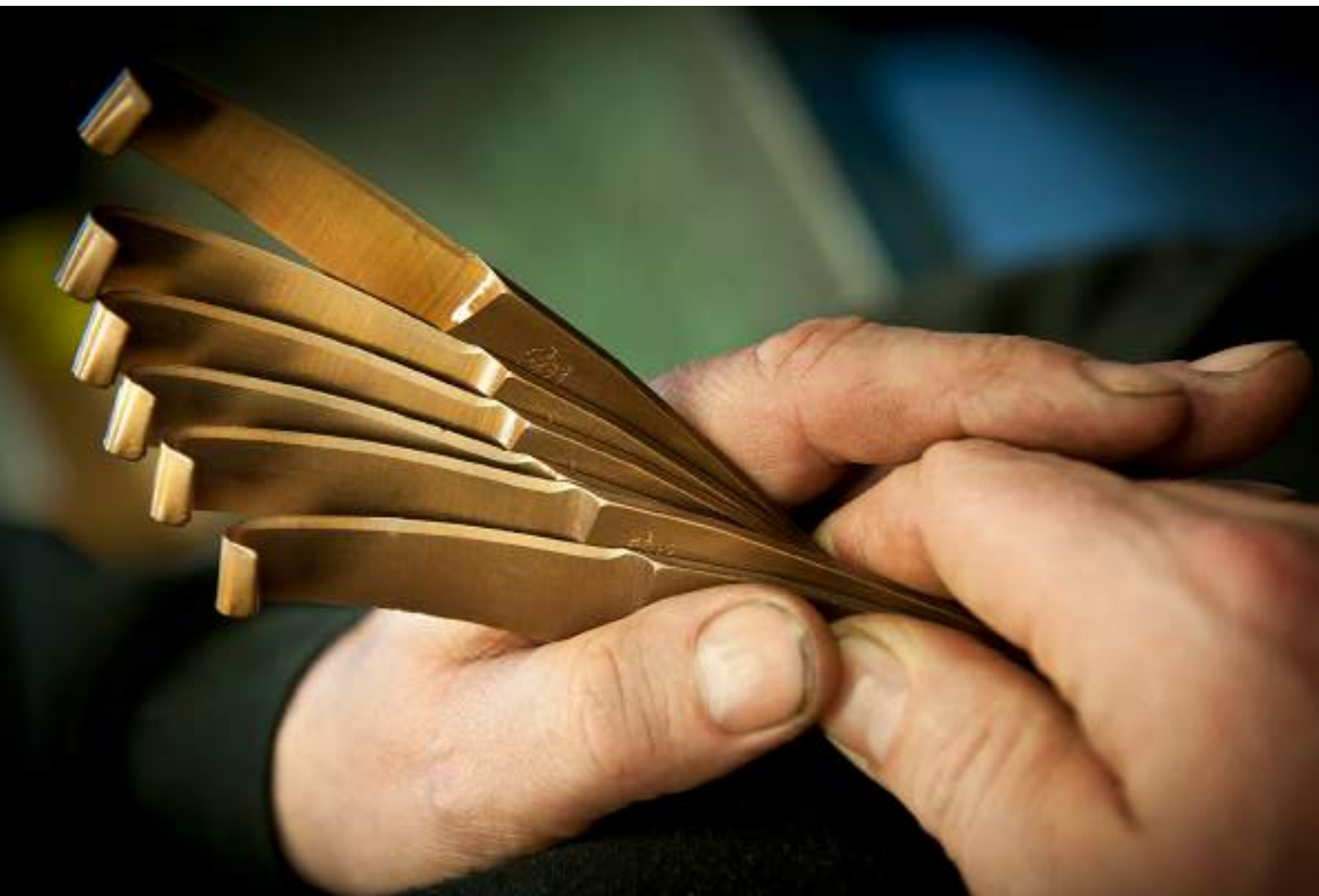



Frosts Toeing knives

Just like our Hoof Trimming knives, the Toeing knives are developed in close collaboration with professionals. The blade of high quality steel is completed with a soft touch polymer handle that makes work easier and more comfortable.



Frosts Toeing 280

Farrier's knife with a blade of carbon steel. Red polymer handle.

Blade material:	Carbon Steel
Blade thickness:	2,5 mm
Blade length:	141 mm
Total length:	283 mm
Item No. 10-pcs/box:	109-1990



Frosts Toeing 330

Farrier's knife with a blade of carbon steel. Red polymer handle.

Blade material:	Carbon Steel
Blade thickness:	2,5 mm
Blade length:	139 mm
Total length:	281 mm
Item No. 10-pcs/box:	109-1980



Frosts Toeing 360

Farrier's knife with a blade of carbon steel. Red polymer handle.

Blade material:	Carbon Steel
Blade thickness:	2,5 mm
Blade length:	220 mm
Total length:	362 mm
Item No. 10-pcs/box:	109-1970





Chris Gregory Collection

The exclusive Chris Gregory collection is the result of a unique collaboration. It was developed through the combination of four generations of professional skills, from the knife-makers of Frosts, and the expertise and experience of the farrier icon Chris Gregory. His deep knowledge of the characteristics of a really good farrier's knife has been invaluable, and the result is both beautiful and effective. A perfect mix of form and functionality.



Frosts Hoof knife 62 CG | Short

Hoof Trimming knife with a blade of stainless steel. Oiled oak handle. Available for both left- and right-handed use.

Blade material:	Stainless Steel
Blade thickness:	2,5 mm
Blade length:	62 mm
Total length:	200 mm
Item No. 12 pcs-bulk Right handed:	11722
Item No. 12 pcs-bulk Left handed:	11723



Frosts Hoof knife 62 CG | Long

Hoof Trimming knife with a blade of stainless steel. Oiled oak handle. Available for both left- and right-handed use.

Blade material:	Stainless Steel
Blade thickness:	2,5 mm
Blade length:	62 mm
Total length:	220 mm
Item No. 12 pcs-bulk Right handed:	11718
Item No. 12 pcs-bulk Left handed:	11719



Frosts Hoof knife 62 CG | Short with pick

Hoof Trimming knife with a blade of stainless steel. The pick is useful when working with hooves or hot fitting. Oiled oak handle. Available for both left- and right-handed use.

Blade material:	Stainless Steel
Blade thickness:	2,5 mm
Blade length:	62 mm
Total length:	224 mm
Item No. 12 pcs-bulk Right handed:	11724
Item No. 12 pcs-bulk Left handed:	11725



Frosts Hoof knife 62 CG | Long with pick

Hoof Trimming knife with a blade of stainless steel. The pick is useful when working with hooves or hot fitting. Oiled oak handle. Available for both left- and right-handed use.

Blade material:	Stainless Steel
Blade thickness:	2,5 mm
Blade length:	62 mm
Total length:	240 mm
Item No. 12-bulk Right handed:	11720
Item No. 12-bulk Left handed:	11721



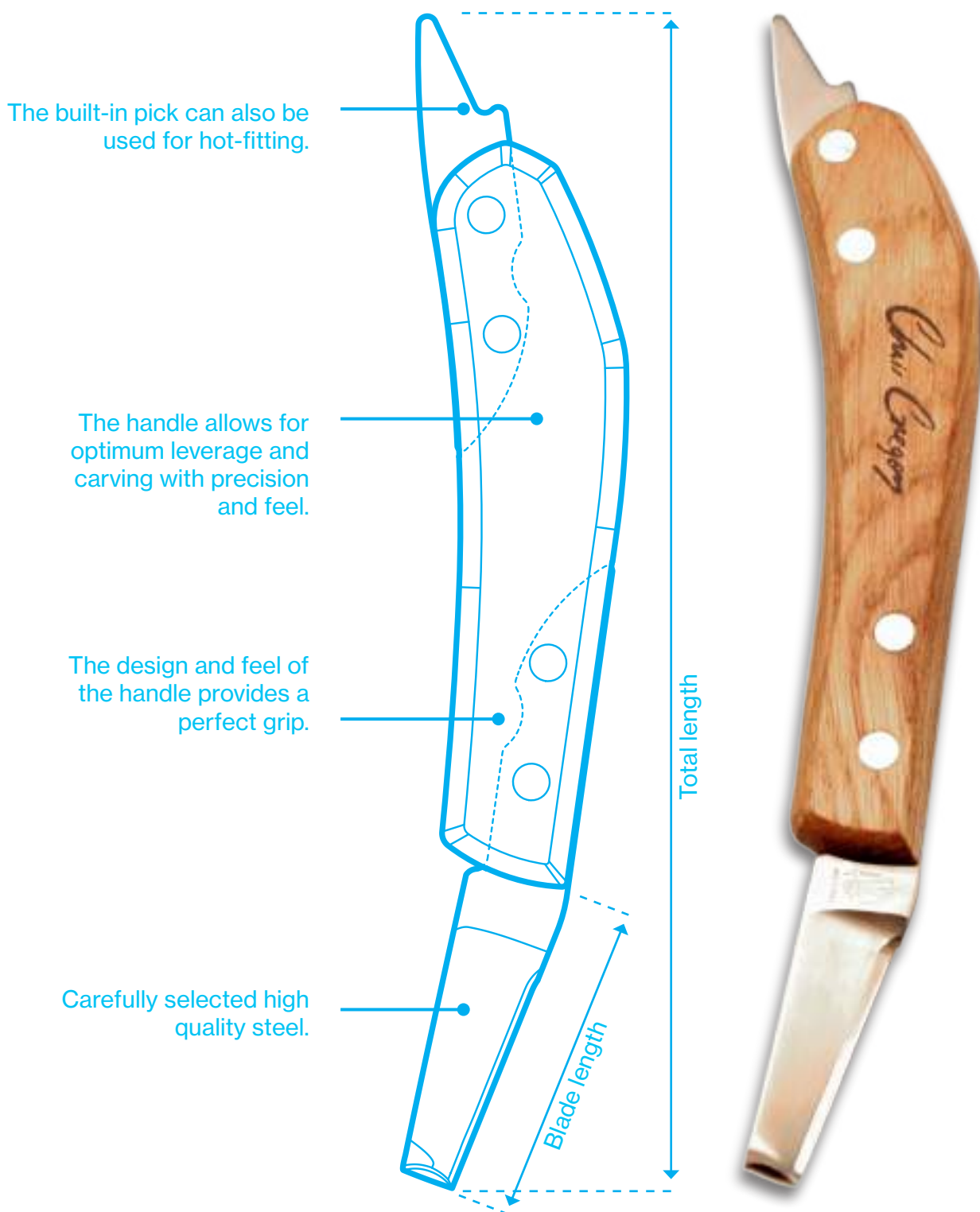

Revolutionary hoof knife design

The farrier knives in the Chris Gregory range have an exclusive handle made of oiled oak, so that it sits really comfortably in the hand. The knives are designed to allow the skilled farrier to achieve the slope and cup to the sole as well as produce the desired angles on the frog. The blade is made of stainless steel and we at Morakniv have made sure that it is of the highest possible quality. The range includes four different models in both longer and shorter versions, so the optimal knife is always close at hand.



**Frosts[®] Professional
Food Industry**

A part of your working day

Frosts[®]
MORA





Frosts® Professional Food Industry

Think about how much time we spend at work. It adds up to a lot of hours in a year, not to mention an entire working life. So, it is important that we enjoy it, not just because of our colleagues and the work itself, but also because we work in a way that means we can and want to be there for a long time. Because our working environment is sustainable for the long-term.

We have collaborated with the most experienced and knowledgeable professionals so that we continuously improve our products. Because we make knives that are meant to be used. For real. So we need to be there on the ground, in your reality. Where you spend every single day. That is what our Frosts brand represents: knives of the very highest quality, for you and your work.



Frosts gives you quality and safety

Our Frost brand carry our range of knives for the professional food industry. We have created models that have been specifically designed for different tasks in slaughterhouses, restaurant kitchens or charcuteries. Every detail has been carefully thought through, from the ergonomic handle that ensures that the movement is steady and safe, to the flexibility of the blade that means you get to every area of the meat. Our knives also prevent repetitive strain injuries and the high quality steel allows you to work effectively for long periods without needing to sharpen the knife.





It's all about the grip

How the knife feels in your hand when working is crucial. Therefore, our four different handle materials are developed with you in mind. For you to be able to perform your tasks with power and precision, in a safe and controlled way, is our highest priority. The different handles each have their specific area of usage. With different materials and different colors you can find a knife for the different tasks that your work place requires.

The handles of our food processing knives are ergonomically designed. This allows work to be done with force, precision and in a controlled manner, which reduces the risk for repetitive strain injuries.

We have four different handle materials, that each serve their special purpose: Ergonomicgrip, G-Grip, Unigrip and Progrip.

Colors can be delivered upon request.

Ergonomicgrip | Elastomer handle

Recommended for beef processing.

E • Double-moulded rubber handle with an etched structure. Suitable for wet conditions.

E1 • Double-moulded rubber handle with an etched structure and finger grips. Suitable for wet conditions.

ER • Double-moulded rubber handle with a ribbed pattern. Size medium standard.

ERS • Double-moulded rubber handle with a ribbed pattern. Size small.

Blade made of Swedish stainless knife steel. Hardened by sub zero treatment, for maximum hardness. Hardness: 58 HRC. Easy to sharpen.

Unigrip | Polyamide handle

Recommended for pork and lamb processing.

Made of polyamide with a microblasted structure for optimum friction. Blade made of Swedish stainless knife steel. Hardened by sub zero treatment, for maximum hardness. Hardness: 58 HRC. Easy to sharpen.

G-Grip | Polyamide handle

Recommended for pork and lamb processing.

G • Made of polyamide with a microblasted structure for optimum friction.

G1 • Handle with finger grips made of polyamide with a microblasted structure for optimum friction.

G2WG • Handle with a large finger guard and grips made of polyamide with a microblasted structure for optimum friction.

Blade made of Swedish stainless knife steel. Hardened by sub zero treatment, for maximum hardness. Hardness: 58 HRC. Easy to sharpen.

Progrip | Elastomer handle

Recommended for beef processing.

Double-moulded rubber handle with an etched pattern. Suitable for wet conditions. Blade made of Swedish stainless knife steel. Hardened by sub zero treatment for maximum hardness. Hardness: 58 HRC. Easy to sharpen.

Frosts Flex Index



Our food industry knives are NSF certified products. The NSF mark is your assurance that the product has been tested by one of the most respected independent certification organizations in existence today. It is valued by consumers, manufacturers, retailers and regulatory agencies worldwide.

The NSF certification mark on a product means that the product complies with all standard requirements. NSF conducts periodic unannounced inspections and product testing to verify that the product continues to comply with the standard.

Ergonomic-grip

Our ergonomic grip handles put focus on function and are developed in close cooperation with meat industry professionals. This has resulted in knife handles with excellent shape, where the ergonomically rounded handle allows a super quick and safe changing of the grip. It also enables you to work at maximum strength in any cutting operation. The grip is designed to be extra suitable for working in wet conditions. The handle material consists of a polypropylene core surrounded by a layer of thermoplastic rubber which significantly increases the friction. They have a warm and soft feel making them comfortable to work with. Chose the ER-grip if you wish to have an extra coarse pattern for even more optimal friction. Both handle varieties are recommended for beef processing.

All knife blades are made of high quality stainless steel (12C27) that can be sharpened to extreme sharpness together with high edge retention.



Curved Boning knife CB5MF-E
Elastomer handle

●	
Blade material:	Stainless Steel
Flex grade:	Medium-Flex
Blade length:	130 mm
Item No. 10 pcs-box:	10643



Curved Boning knife CB5MF-ER
Ribbed Elastomer

● ● ● ● ● ●	
Blade material:	Stainless Steel
Flex grade:	Medium-Flex
Blade length:	130 mm
Item No. 10 pcs-box:	11328



Curved Boning knife CB5S-E
Elastomer handle

● ●	
Blade material:	Stainless Steel
Flex grade:	Stiff
Blade length:	130 mm
Item No. 10 pcs-box:	10251



Curved Boning knife CB5S-ER
Ribbed Elastomer handle

● ●	
Blade material:	Stainless Steel
Flex grade:	Stiff
Blade length:	130 mm
Item No. 10 pcs-box:	11326



Curved Boning knife CB6F-E
Elastomer handle

●	
Blade material:	Stainless Steel
Flex grade:	Flex
Blade length:	153 mm
Item No. 10 pcs-box:	10253



Curved Boning knife CB6XF-ER
Ribbed Elastomer handle

●	
Blade material:	Stainless Steel
Flex grade:	Extra-Flex
Blade length:	153 mm
Item No. 10 pcs-box:	10255



Curved Boning knife CB6S-E
Elastomer handle

●	
Blade material:	Stainless Steel
Flex grade:	Stiff
Blade length:	153 mm
Item No. 10 pcs-box:	10254



Curved Boning knife CB6XF-ERS
Elastomer handle

●	
Blade material:	Stainless Steel
Flex grade:	Extra-Flex
Blade length:	153 mm
Item No. 10 pcs-box:	10256



Curved Boning knife CB6MF-ER
Elastomer handle

● ●	
Blade material:	Stainless Steel
Flex grade:	Medium-Flex
Blade length:	153 mm
Item No. 10 pcs-box:	11329



Curved Boning knife CB6S-ER
Elastomer handle

● ●	
Blade material:	Stainless Steel
Flex grade:	Stiff
Blade length:	153 mm
Item No. 10 pcs-box:	11327



Curved Boning knife CT8S-E1
Elastomer handle

●	
Blade material:	Stainless Steel
Flex grade:	Stiff
Blade length:	210 mm
Item No. 10 pcs-box:	10257



Hard core for complete stability.

High friction rubber grip suitable for wet conditions.

Ergonomically designed for quick and safe grip change with maximum strength.

Seamless connection of blade and handle core.

Polished durable Swedish steel blade.

Extremely sharp edge with high edge retention.

G-grip

These ergonomic G-grip handles put grip and safety in fatty environments in focus. They are developed in close cooperation with professionals within the meat industry, giving them an excellent shaped ergonomically rounded handle. The handle is made of a polyamide with a soft “feel” and high friction characteristics, unaffected by fats or humidity. The handle surface has a micro-structure resembling sharp crystals which resist wear extremely well. Add to this the slip-resistant qualities and you’ve got all you need. Knives with G-grip handles are recommended for pork and lamb processing. All knife blades are made of high quality stainless steel (12C27) that can be sharpened to extreme sharpness together with high edge retention.



Curved Boning knife CB5F-G
Polyamide handle

Blade material:	Stainless Steel
Flex grade:	Flexible
Blade length:	133 mm
Item No. 10 pcs-box:	10867



Curved Boning knife CB6S-G
Polyamide handle

Blade material:	Stainless Steel
Flex grade:	Stiff
Blade length:	153 mm
Item No. 10 pcs-box:	10874



Curved Boning knife CB5F-G1
Polyamide handle

Blade material:	Stainless Steel
Flex grade:	Flexible
Blade length:	133 mm
Item No. 10 pcs-box:	10902



Curved Boning knife CB6S-G1
Polyamide handle

Blade material:	Stainless Steel
Flex grade:	Stiff
Blade length:	153 mm
Item No. 10 pcs-box:	10875



Curved Boning knife CB5S-G
Polyamide handle

Blade material:	Stainless Steel
Flex grade:	Stiff
Blade length:	133 mm
Item No. 10 pcs-box:	10885



Straight Narrow Boning knife SB4MF-G
Polyamide handle

Blade material:	Stainless Steel
Flex grade:	Medium-Flex
Blade length:	95 mm
Item No. 10 pcs-box:	1-0132



Curved Boning knife CB6F-G
Polyamide handle

Blade material:	Stainless Steel
Flex grade:	Flex
Blade length:	153 mm
Item No. 10 pcs-box:	10868



Straight Narrow Boning knife SB5MF-G
Polyamide handle

Blade material:	Stainless Steel
Flex grade:	Medium-Flex
Blade length:	135 mm
Item No. 10 pcs-box:	10892



Curved Boning knife CB6F-G1
Polyamide handle

Blade material:	Stainless Steel
Flex grade:	Flexible
Blade length:	153 mm
Item No. 10 pcs-box:	10903



Straight Narrow Boning knife SB5S-G
Polyamide handle

Blade material:	Stainless Steel
Flex grade:	Stiff
Blade length:	135 mm
Item No. 10 pcs-box:	10871



Straight Narrow Boning knife SB5MF-G1
Polyamide handle

Blade material:	Stainless Steel
Flex grade:	Medium-Flex
Blade length:	135 mm
Item No. 10 pcs-box:	10891



Straight Narrow Boning knife SB5S-G1
Polyamide handle

Blade material:	Stainless Steel
Flex grade:	Stiff
Blade length:	135 mm
Item No. 10 pcs-box:	11338



Straight Narrow Boning knife SB6MF-G
Polyamide handle

Blade material:	Stainless Steel
Flex grade:	Medium-Flex
Blade length:	156 mm
Item No. 10 pcs-box:	10889



Straight Narrow Boning knife SB6MF-G1
Polyamide handle

Blade material:	Stainless Steel
Flex grade:	Medium-Flex
Blade length:	156 mm
Item No. 10 pcs-box:	10890



Curved Skinning knife CS6S-G1
Polyamide handle

Blade material:	Stainless Steel
Flex grade:	Stiff
Blade length:	168 mm
Item No. 10 pcs-box:	10897



Lamb Skinner LS5S-G1
Polyamide handle

Blade material:	Stainless Steel
Flex grade:	Stiff
Blade length:	140 mm
Item No. 10 pcs-box:	10886



Slip-resistant microstructure unaffected by fats or humidity.

Focus on grip and safety in fatty environments.

Handle with finger grips made of polyamide with a microblasted structure for optimum friction.

Seamless connection of blade and handle core.

Polished durable Swedish steel blade.

Extremely sharp edge with high edge retention.



Straight Header SH8-G2WG
Polyamide handle

●	
Blade material:	Stainless Steel
Flex grade:	Stiff
Blade length:	203 mm
Item No. 10 pcs-box:	10861



Straight Header SH8-G1
Polyamide handle

●	
Blade material:	Stainless Steel
Flex grade:	Stiff
Blade length:	203 mm
Item No. 10 pcs-box:	10865



Straight Header SH8-G3WG
Polyamide handle

●	
Blade material:	Stainless Steel
Flex grade:	Stiff
Blade length:	203 mm
Item No. 10 pcs-box:	10863



Butcher knife 149-G2WG
Polyamide handle

●	
Blade material:	Stainless Steel
Flex grade:	Stiff
Blade length:	151 mm
Item No. 10 pcs-box:	1-0149



Butcher knife 147-G2WG
Polyamide handle

●	
Blade material:	Stainless Steel
Flex grade:	Stiff
Blade length:	205 mm
Item No. 10 pcs-box:	1-0147



Narrow Boning knife 141-15°BE-G
Polyamide handle

●	
Blade material:	Stainless Steel
Flex grade:	Stiff
Blade length:	132 mm
Item No. 10 pcs-box:	1-0141



Belly Ham Trim knife 137-90°-G
Polyamide handle

●	
Blade material:	Stainless Steel
Flex grade:	Stiff
Blade length:	157 mm
Item No. 10 pcs-box:	1-0137



Unigrip

The unigrip handles are made of polyamide with a soft “feel” and high friction characteristics that stay unaffected when in contact with fats or humidity. The handle surface has a micro-structure that resembles sharp crystals which resist wear extremely well. Add to this the slip-resistant qualities and you’ve got a real winner. This handle is recommended for the widest variety of cutting operations, especially for pork and lamb processing. All knife blades are made of high quality stainless steel (12C27) that can be sharpened to extreme sharpness together with high edge retention.



Curved Boning knife 9124 UG
Polyamide handle

●	
Blade material:	Stainless Steel
Flex grade:	Flexible
Blade length:	124 mm
Item No. 10 pcs-box:	128-5257



Curved Boning knife 8124 UG
Polyamide handle

●	
Blade material:	Stainless Steel
Flex grade:	Medium-Flex
Blade length:	124 mm
Item No. 10 pcs-box:	128-0727



Extra Curved Boning knife 8124 UUG
Polyamide handle

●	
Blade material:	Stainless Steel
Flex grade:	Medium-Flex
Blade length:	124 mm
Item No. 10 pcs-box:	128-0737



Curved Scalloped Boning knife 8124 UGW
Polyamide handle

●	
Blade material:	Stainless Steel
Flex grade:	Medium-Flex
Blade length:	124 mm
Item No. 10 pcs-box:	128-07240



Curved Boning knife 7124 UG
Polyamide handle

●	
Blade material:	Stainless Steel
Flex grade:	Stiff
Blade length:	124 mm
Item No. 10 pcs-box:	128-5827



Curved Boning knife 8154 UG
Polyamide handle

●	
Blade material:	Stainless Steel
Flex grade:	Medium-Flex
Blade length:	154 mm
Item No. 10 pcs-box:	128-0717



Curved Boning knife 7154 UG
Polyamide handle

●	
Blade material:	Stainless Steel
Flex grade:	Stiff
Blade length:	154 mm
Item No. 10 pcs-box:	128-5867



Curved Boning knife 8158 UG
Polyamide handle

●	
Blade material:	Stainless Steel
Flex grade:	Medium-Flex
Blade length:	158 mm
Item No. 10 pcs-box:	128-0707



Curved Wide Boning knife 7158 UG
Polyamide handle

●	
Blade material:	Stainless Steel
Flex grade:	Stiff
Blade length:	158 mm
Item No. 10 pcs-box:	128-5857



Curved Boning knife 7158 UGW
Polyamide handle

●	
Blade material:	Stainless Steel
Flex grade:	Stiff
Blade length:	158 mm
Item No. 10 pcs-box:	128-58540



Wide Boning knife 7132 UG
Polyamide handle

Blade material:	Stainless Steel
Flex grade:	Stiff
Blade length:	135 mm
Item No. 10 pcs-box:	128-5837



Wide Boning knife 7157 UG
Polyamide handle

Blade material:	Stainless Steel
Flex grade:	Stiff
Blade length:	157 mm
Item No. 10 pcs-box:	128-5847



Wide Boning knife 7130 UG
Polyamide handle

Blade material:	Stainless Steel
Flex grade:	Stiff
Blade length:	125 mm
Item No. 10 pcs-box:	128-6117



Wide Boning knife 7153 UG
Polyamide handle

Blade material:	Stainless Steel
Flex grade:	Stiff
Blade length:	153 mm
Item No. 10 pcs-box:	128-6137



Straight Narrow Boning knife 7126 UG
Polyamide handle

Blade material:	Stainless Steel
Flex grade:	Stiff
Blade length:	131 mm
Item No. 10 pcs-box:	128-6017



Straight Narrow Boning knife 7151 UG
Polyamide handle

Blade material:	Stainless Steel
Flex grade:	Stiff
Blade length:	151 mm
Item No. 10 pcs-box:	128-6027



Slip-resistant microstructure unaffected by fats or humidity.

Soft feel.

Safe defined fingerguard.

Seamless connection of blade and handle core.

Extremely sharp edge with high edge retention.

Polished durable Swedish steel blade.



Scand. Butcher knife 133 UG
Polyamide handle

●	
Blade material:	Stainless Steel
Flex grade:	Stiff
Blade length:	136 mm
Item No. 10 pcs-box:	128-5317



Wide Butcher knife 7145 UG
Polyamide handle

●	
Blade material:	Stainless Steel
Flex grade:	Stiff
Blade length:	160 mm
Item No. 10 pcs-box:	128-5617



Scand. Butcher knife 161 UG
Polyamide handle

●	
Blade material:	Stainless Steel
Flex grade:	Stiff
Blade length:	163 mm
Item No. 10 pcs-box:	128-5337



Wide Butcher knife 7177 UG
Polyamide handle

●	
Blade material:	Stainless Steel
Flex grade:	Stiff
Blade length:	182 mm
Item No. 10 pcs-box:	128-5627



Scand. Butcher/Trimming knife 185 UG
Polyamide handle

●	
Blade material:	Stainless Steel
Flex grade:	Stiff
Blade length:	183 mm
Item No. 10 pcs-box:	128-5347



Wide Butcher knife 7212 UG
Polyamide handle

● ● ●	
Blade material:	Stainless Steel
Flex grade:	Stiff
Blade length:	210 mm
Item No. 10 pcs-box:	128-5637



Scand. Trimming knife 7215 UG
Polyamide handle

●	
Blade material:	Stainless Steel
Flex grade:	Stiff
Blade length:	215 mm
Item No. 10 pcs-box:	128-5427



Wide Butcher knife 7250 UG
Polyamide handle

●	
Blade material:	Stainless Steel
Flex grade:	Stiff
Blade length:	260 mm
Item No. 10 pcs-box:	11184



Skinning knife 7146 UG
Polyamide handle

●	
Blade material:	Stainless Steel
Flex grade:	Stiff
Blade length:	146 mm
Item No. 10 pcs-box:	128-5717



Steak knife 7253 UG
Polyamide handle

●	
Blade material:	Stainless Steel
Flex grade:	Stiff
Blade length:	253 mm
Item No. 10 pcs-box:	11182



Sticking knife 7160 UG
Polyamide handle

●	
Blade material:	Stainless Steel
Flex grade:	Stiff
Blade length:	160 mm
Item No. 10 pcs-box:	127-5880



Steak knife 7305 UG
Polyamide handle

●	
Blade material:	Stainless Steel
Flex grade:	Stiff
Blade length:	310 mm
Item No. 10 pcs-box:	11183



Narrow Fillet knife 9218 UG
Polyamide handle

●	
Blade material:	Stainless Steel
Flex grade:	Medium-Flex
Blade length:	212 mm
Item No. 10 pcs-box:	128-0907



Narrow Fillet knife 8197 UG
Polyamide handle

●	
Blade material:	Stainless Steel
Flex grade:	Medium-Flex
Blade length:	198 mm
Item No. 10 pcs-box:	128-5039



Filleting knife 8180 UG
Polyamide handle

●	
Blade material:	Stainless Steel
Flex grade:	Medium-Flex
Blade length:	180 mm
Item No. 10 pcs-box:	128-0917



Chef's knife 4261 UG
Polyamide handle

●	
Blade material:	Stainless Steel
Flex grade:	Stiff
Blade length:	261 mm
Item No. 10 pcs-box:	11180



Narrow Fillet knife 9197 UG
Polyamide handle

●	
Blade material:	Stainless Steel
Flex grade:	Flexible
Blade length:	198 mm
Item No. 10 pcs-box:	128-5037



Poultry knife 9090 UG
Polyamide handle

●	
Blade material:	Stainless Steel
Flex grade:	Medium-Flex
Blade length:	100 mm
Item No. 10 pcs-box:	128-5267



Progrip

Our Progrip models have a double-moulded rubber handle with an etched structure that makes them especially suitable for wet conditions. The polypropylene core is surrounded by a layer of thermoplastic rubber. This significantly increases the friction of the handle and makes it more comfortable to work with, since it generates a warm and soft feel. All knife blades are made of high quality stainless steel (12C27) that can be sharpened to extreme sharpness and has high edge retention. These models are especially recommended for beef processing.



Curved Boning knife 9124 PG
Elastomer handle



Blade material:	Stainless Steel
Flex grade:	Flexible
Blade length:	124 mm
Item No. 10 pcs-box:	129-3830



Extra Curved Boning knife 9154 PG
Elastomer handle



Blade material:	Stainless Steel
Flex grade:	Flexible
Blade length:	154 mm
Item No. 10 pcs-box:	129-3810



Curved Boning knife 8124 PG
Elastomer handle



Blade material:	Stainless Steel
Flex grade:	Medium-Flex
Blade length:	124 mm
Item No. 10 pcs-box:	129-3965



Curved Boning knife 8154 PG
Elastomer handle



Blade material:	Stainless Steel
Flex grade:	Medium-Flex
Blade length:	154 mm
Item No. 10 pcs-box:	129-3945



Curved Boning knife 8124 UPG
Elastomer handle



Blade material:	Stainless Steel
Flex grade:	Medium-Flex
Blade length:	124mm
Item No. 10 pcs-box:	129-3968



Extra Curved Boning knife 7154PG
Elastomer handle



Blade material:	Stainless Steel
Flex grade:	Stiff
Blade length:	154 mm
Item No. 10 pcs-box:	129-3940



Curved Boning knife 7124 PG
Elastomer handle



Blade material:	Stainless Steel
Flex grade:	Stiff
Blade length:	124 mm
Item No. 10 pcs-box:	129-3970



Wide Curved Boning knife 8158PG
Elastomer handle



Blade material:	Stainless Steel
Flex grade:	Medium-Flex
Blade length:	158 mm
Item No. 10 pcs-box:	129-3905



Extra Curved Boning knife 7158 PG
Elastomer handle



Blade material:	Stainless Steel
Flex grade:	Stiff
Blade length:	157 mm
Item No. 10 pcs-box:	129-3900



Straight Wide Boning knife 7179 PG
Elastomer handle



Blade material:	Stainless Steel
Flex grade:	Stiff
Blade length:	179 mm
Item No. 10 pcs-box:	129-4020



Wide Boning knife 7132 PG
Elastomer handle

● ●	
Blade material:	Stainless Steel
Flex grade:	Stiff
Blade length:	135 mm
Item No. 10 pcs-box:	129-3920



Straight Wide Boning knife 7153 PG
Elastomer handle

●	
Blade material:	Stainless Steel
Flex grade:	Stiff
Blade length:	153 mm
Item No. 10 pcs-box:	129-3980



Boning knife 7159 PG
Elastomer handle

●	
Blade material:	Stainless Steel
Flex grade:	Stiff
Blade length:	159 mm
Item No. 10 pcs-box:	129-3910



Straight Wide Boning knife 9153 PG
Elastomer handle

● ●	
Blade material:	Stainless Steel
Flex grade:	Medium-Flex
Blade length:	153 mm
Item No. 10 pcs-box:	129-3795



Wide Boning knife 7157 PG
Elastomer handle

● ●	
Blade material:	Stainless Steel
Flex grade:	Stiff
Blade length:	157 mm
Item No. 10 pcs-box:	129-3930



Straight Narrow Boning knife 7151 PG
Elastomer handle

●	
Blade material:	Stainless Steel
Flex grade:	Stiff
Blade length:	152 mm
Item No. 10 pcs-box:	129-3960



Scand. Butcher knife 161 PG
Elastomer handle

●	
Blade material:	Stainless Steel
Flex grade:	Stiff
Blade length:	161 mm
Item No. 10 pcs-box:	129-3880



Straight Narrow Boning knife 7126 PG
Elastomer handle

●	
Blade material:	Stainless Steel
Flex grade:	Stiff
Blade length:	131 mm
Item No. 10 pcs-box:	129-3950



Scand. Trimming knife 7215 PG
Elastomer handle

●	
Blade material:	Stainless Steel
Flex grade:	Stiff
Blade length:	215 mm
Item No. 10 pcs-box:	129-3990



Narrow Fillét knife 9160 PG
Elastomer handle

●	
Blade material:	Stainless Steel
Flex grade:	Flexible
Blade length:	160 mm
Item No. 10 pcs-box:	129-3835



Narrow Fillét knife 9174 PG
Elastomer handle

●	
Blade material:	Stainless Steel
Flex grade:	Flexible
Blade length:	174 mm
Item No. 10 pcs-box:	129-3800



Narrow Fillét knife 8180 PG
Elastomer handle

●	
Blade material:	Stainless Steel
Flex grade:	Medium-Flex
Blade length:	180 mm
Item No. 10 pcs-box:	129-3710



Narrow Fillét knife 9180 PG
Elastomer handle

●	
Blade material:	Stainless Steel
Flex grade:	Flexible
Blade length:	175 mm
Item No. 10 pcs-box:	129-3805



Narrow Fillét knife 9197 PG
Elastomer handle

●	
Blade material:	Stainless Steel
Flex grade:	Flexible
Blade length:	196 mm
Item No. 10 pcs-box:	129-3850



Wide Fillét knife 9210 PG
Elastomer handle

●	
Blade material:	Stainless Steel
Flex grade:	Medium-Flex
Blade length:	210 mm
Item No. 10 pcs-box:	129-3855



Narrow Fillét knife 9218 PG
Elastomer handle

●	
Blade material:	Stainless Steel
Flex grade:	Medium-Flex
Blade length:	212 mm
Item No. 10 pcs-box:	129-3790



Narrow Fillét knife 9151 PG
Elastomer handle

● ● ●	
Blade material:	Stainless Steel
Flex grade:	Medium-Flex
Blade length:	151 mm
Item No. 10 pcs-box:	129-3820

Polished durable Swedish steel blade.

Seamless connection of blade and handle core.

Hard core for complete stability.



Extremely sharp edge with high edge retention.

Safe defined finger guard.

High friction rubber grip suitable for wet conditions.



P-grip

The knives with P-grip have a polypropylene handle with a rough structure and is one of our most valuable alternatives. To increase the friction even further we've also reinforced the handle with glass-fiber. The knives can be used in various settings and are especially appreciated by professionals within the Fish Industry. All knives have blades of stainless steel (12C27) that can be sharpened to extreme sharpness together with high edge retention.



Straight Wide Boning knife 9130P
Propylene handle

●	
Blade material:	Stainless Steel
Flex grade:	Medium-Flex
Blade length:	130 mm
Item No. 10 pcs-box:	121-5040



Narrow Fillet knife 9156P
Propylene handle

●	
Blade material:	Stainless Steel
Flex grade:	Flexible
Blade length:	153 mm
Item No. 10 pcs-box:	121-5010



Straight Wide Boning knife 9153P
Propylene handle

●	
Blade material:	Stainless Steel
Flex grade:	Medium-Flex
Blade length:	152 mm
Item No. 10 pcs-box:	121-5050



Narrow Fillet knife 9160P
Propylene handle

●	
Blade material:	Stainless Steel
Flex grade:	Flexible
Blade length:	158 mm
Item No. 10 pcs-box:	121-5090



Wide Fillet knife 9210P
Propylene handle

●	
Blade material:	Stainless Steel
Flex grade:	Medium-Flex
Blade length:	213 mm
Item No. 10 pcs-box:	121-5060



Narrow Fillet knife 9174P
Propylene handle

●	
Blade material:	Stainless Steel
Flex grade:	Flexible
Blade length:	174 mm
Item No. 10 pcs-box:	121-5080



Narrow Fillet knife 9151P
Propylene handle

●	
Blade material:	Stainless Steel
Flex grade:	Flexible
Blade length:	155 mm
Item No. 10 pcs-box:	121-5070



Narrow Fillet knife 9180P
Propylene handle

●	
Blade material:	Stainless Steel
Flex grade:	Flexible
Blade length:	180 mm
Item No. 10 pcs-box:	121-5020



Curved Fillet knife 9154P
Propylene handle

●	
Blade material:	Stainless Steel
Flex grade:	Flexible
Blade length:	156 mm
Item No. 10 pcs-box:	121-5160



Narrow Fillet knife 9197P
Propylene handle

●	
Blade material:	Stainless Steel
Flex grade:	Flexible
Blade length:	199 mm
Item No. 10 pcs-box:	121-5030

Poultry Knives

These knives are made especially for working with poultry, where the somewhat shorter blades are convenient for handling chicken and turkey. The knife blades are made of Swedish high quality steel (12C27) which makes it possible to sharpen the knife to extreme sharpness. These knives also have a very high edge retention.



Poultry knife 9092 PAM
Propylene handle

●	
Blade material:	Stainless Steel
Flex grade:	Stiff
Blade length:	92 mm
Item No. 10 pcs-box:	138-6850



Poultry knife 9090 UG
Polyamide handle

●	
Blade material:	Stainless Steel
Flex grade:	Medium-Flex
Blade length:	100 mm
Item No. 10 pcs-box:	128-5267



Food Service

Restaurants, charcuteries, hotels or wherever you serve your food - we've got a high quality knife for you. Our range developed for food service consists of models with various features and handles. This way you can chose the one that best suits you and your work. In common for all models are of course that the premium cutting tools all have blades of high quality stainless steel (12C27) that can be sharpened to extreme sharpness. The high edge retention makes the knives a perfect partner in your professional kitchen.



Chef's knife 4216 PG
Elastomer handle

●	
Blade material:	Stainless Steel
Flex grade:	Stiff
Blade length:	216 mm
Item No. 10 pcs-box:	129-40520



Chef's knife 4171 PG
Elastomer handle

●	
Blade material:	Stainless Steel
Flex grade:	Stiff
Blade length:	176 mm
Item No. 10 pcs-box:	129-40515



Chef's knife 4216 P
Propylene handle

●	
Blade material:	Stainless Steel
Flex grade:	Stiff
Blade length:	216 mm
Item No. 10 pcs-box:	133-6620



Chef's knife 4171 P
Propylene handle

●	
Blade material:	Stainless Steel
Flex grade:	Stiff
Blade length:	175 mm
Item No. 10 pcs-box:	133-6610



Chef's knife 4130 PG
Propylene handle

●	
Blade material:	Stainless Steel
Flex grade:	Stiff
Blade length:	130 mm
Item No. 10 pcs-box:	129-40500



Bread knife 3214 PG
Elastomer handle

●	
Blade material:	Stainless Steel
Flex grade:	Stiff
Blade length:	214 mm
Item No. 10 pcs-box:	129-40960



Slicing knife 3305 PG
Elastomer handle

●	
Blade material:	Stainless Steel
Flex grade:	Stiff
Blade length:	301 mm
Item No. 10 pcs-box:	129-40630



Bread knife 3214 P
Propylene handle

●	
Blade material:	Stainless Steel
Flex grade:	Stiff
Blade length:	211 mm
Item No. 10 pcs-box:	138-6860



Paring knife 4085 PAM
Propylene handle

●	
Blade material:	Stainless Steel
Flex grade:	Stiff
Blade length:	85 mm
Item No. 10 pcs-box:	138-6820



Vegetable knife 4118 PAM
Propylene handle

●	
Blade material:	Stainless Steel
Flex grade:	Medium-Flex
Blade length:	118 mm
Item No. 10 pcs-box:	138-6810



Sharpening steels

The longer we can keep and use our knives, the better, both from an economical and a sustainable perspective. With our Frosts sharpening steels you can be sure that your knives always get the best possible treatment when they need to be freshened up and resharpened. Our sharpening steels come in various models, with longer or shorter steels and different edges.



Sharpening Steel Round P203-10"
Propylene handle

Cut:	Regular Cut
Steel length:	250 mm
Item No. 6 pcs-box:	161-5910



Sharpening Steel Elliptic EP203-12"
Propylene handle

Cut:	Regular Cut
Steel length:	309 mm
Item No. 6 pcs-box:	162-5960



Sharpening Steel Round P203-12"
Propylene handle

Cut:	Regular Cut
Steel length:	305 mm
Item No. 6 pcs-box:	161-5920



Sharpening Steel Elliptic EP203-14"
Propylene handle

Cut:	Regular Cut
Steel length:	350 mm
Item No. 6 pcs-box:	163-5970



Sharpening Steel Round P203-14"
Propylene handle

Cut:	Regular Cut
Steel length:	355 mm
Item No. 6 pcs-box:	161-5930



Sharpening Steel Elliptic EP203-12" MF
Propylene handle

Cut:	Microfine
Steel length:	310 mm
Item No. 6 pcs-box:	162-5961



Sharpening Steel Square P53-10"
Propylene handle

Cut:	Polished/Fine
Steel length:	255 mm
Item No. 6 pcs-box:	165-5989



MORAKNIV
Made in Mora, Sweden



Knife care

Knife care is time well invested. Take good care of your knife and it will keep even longer. Different knives have differing sensitivities to the impacts from their surroundings and the situations you use them in. The main thing to consider is whether the blade is made of stainless or carbon steel. Read our tips on knife care and you'll see that the same knife will remain with you in the kitchen, on your fishing trip, or in your tool-box for a long time to come. We also offer a number of products to simplify your knife care.

Different types of sharpeners and whetstones that you can use to make sure your knives are always really sharp and effective. Remember that carbon steel knives are easier to re-sharpen than stainless steel versions. It's a good idea to use a very fine stone or diamond Honer and as an extra finish Strop the edge on a leather strap. You can usually use the back side of your leather belt with good result.

Sharpening and knife care can be a little tricky in the beginning, but practice makes perfect and you'll soon be sharpening with ease. There are also many good instruction films on the Internet and tips in various forums if you want to learn more.



Morakniv Diamond Sharpener 26 Fine

A fine (600) diamond sharpener used to keep knives and axes in good shape. It also has a specially designed groove for grinding fishing hooks (not applicable for knife edges). Its minimalist design makes it easy to bring along in your pocket or backpack. You can keep it extra safe in the accompanying leather case.

Thickness:	6,5 mm
Length:	76 mm
Total length:	76 mm
Item No. 1 pcs-PinPac 5/ctn:	501-9860



Morakniv Diamond Sharpener S

A fine (600) pen type diamond sharpening rod for keeping your knives, scissors, and axes in the best possible shape, since it naturally allows you to follow the knife's edge. The diamond sharpener has both a rounded and a flat side. It also has a specially designed groove for grinding fishing hooks (not applicable for knife edges).

Rod thickness:	4,0 mm
Rod length:	54 mm
Total length:	140 mm
Item No. 1 pcs-PinPac 5/ctn:	11968



Morakniv Diamond Sharpener L Fine

A fine (600) pocket diamond sharpener. The flat steel easily follows the angle of the edge. A long lasting and very durable sharpening tool.

Thickness:	4,5 mm
Length:	50 mm
Total length:	150 mm
Item No. 1 pcs-PinPac 5/ctn:	11883



Using the sharpening steel

Our knives stay razor sharp for a long time.

What usually happens when a knife loses its sharpness is that rather than chipping, the top of the edge bends to one side.

The sharpening steel works by aligning the edge back into a central position.

A good sharpening steel is almost as important as the knife itself. We have steels in different models: from coarser to finer ones. A smooth polishing steel gives the knife edge maximum sharpness by aligning the edge. Some steels also have a coarser side that is used for grinding when the edge is worn down. Remember to finish sharpening with the polished surface.

To sharpen the knife, pull the knife's edge a few times lightly against a sharpening steel at a 15-20 degree angle. Switch between both sides of the knife.

The knife should be placed against the sharpening steel at the same angle as the cutting edge. This angle between the sharpening steel and knife edge must be maintained while drawing the knife from the back to the tip.

The last "draw" should be very light, gently caressing the knife edge.

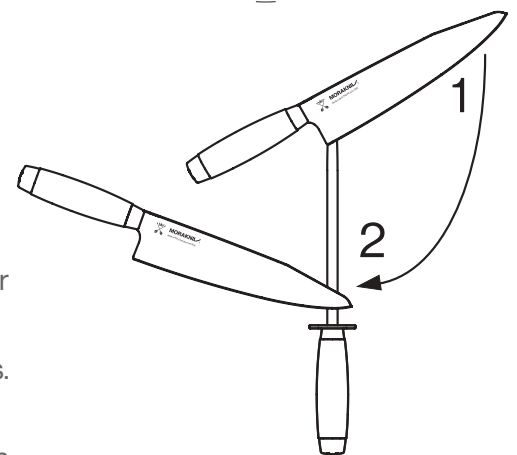
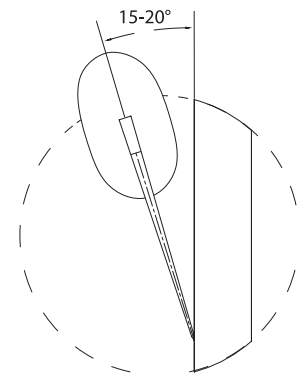
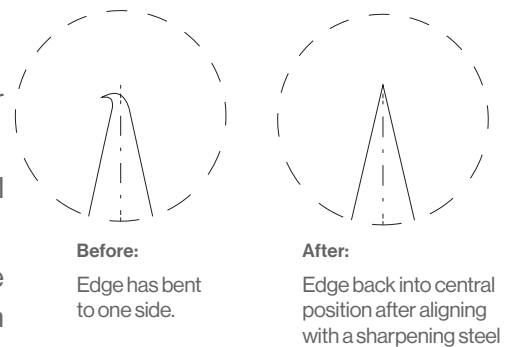

Care for your kitchen knives

Wash your knife with warm water and a soft sponge before using it for the first time.

Never cut bones, frozen food, porcelain, glass and other hard materials. The thinnest part of the blade can easily be deformed.

Do not clean the knives in a dishwasher. Dishwasher detergents contain abrasives that make the knife blunt and damage the wooden finish.

Do not allow acidic residues (lemons, limes, orange, grapefruits, tomatoes, onions) to stay on the blades for extended periods of time.

Always thoroughly clean and wipe your knives dry before storing. Leaving knives wet or to drip-dry may result in discoloration.

Once you have cut, do not scrape the cutting board with the knife's edge. As it dulls the blade. Instead, turn the knife around and scrape with the back of the knife.



Never cut hard substances.



Wash only by hand.

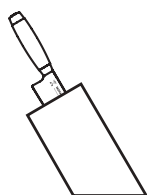

Store in knife block or magnetic knife strip.

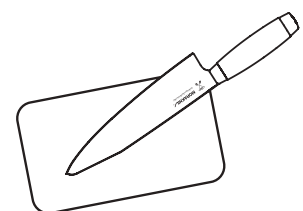
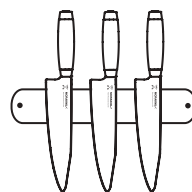

Use wooden or polypropylene chopping boards.

The steel

The knife blade has become one of the main characteristics for Morakniv, due to its high quality, design and sharpness. We've refined our methods and constantly worked to improve our products for more than 127 years. How we treat, harden and polish our knives is a vital part of our quality work, and the recipe is a well-kept company secret. Morakniv's way of treating the steel is based on well-proven and unique expertise we possess in materials technology and our insight into knife usage and applications. This combination has resulted in the capability to give our knives the steel's unique qualities – such as sharpness, strength and flexibility. We call it Steel Grade Mora/SGM®.

This results in knives that will always live up to your expectations and that you can always put your trust in.

The blade of a Morakniv can be made of three different kinds of steel: stainless steel, carbon steel or laminated steel. Each steel type has its unique properties, this determines which model is being matched with which steel.

Stainless steel (S)

We mainly use Swedish stainless steel - 12C27 and 14C28N, hardened to HRC 56-58 - for our knives with extreme strength and a long life. They also have a very high resistance to moisture, which otherwise can make the blades rust. Stainless steel stays sharp for much longer than carbon steel and is far less sensitive to rust.

Carbon steel (C)

We use carbon steel according to O1, that is knife steel alloyed with 1 % carbon. Knife blades of high carbon steel can be hardened to HRC 58-60, giving them the best possible sharpness at an affordable price. When used, knives made from the above steel grades eventually achieve a dull grey finish. However, this will not affect the quality of the blade, but rather improve the resistance to corrosion. Carbon steel is easy to sharpen, but requires more maintenance when exposed to moist or corrosive environment. Make sure to keep the blade clean and dry. For example, fruit acids immediately leave spots on the blade.

Morakniv blades are provided with a scandi grind.

The Scandi grind prevents the knife from slipping off easily like a blade with convex grinding tends to do and gives a good grip. It bites into the surface, but without getting stuck like a blade with a hollow grind does.

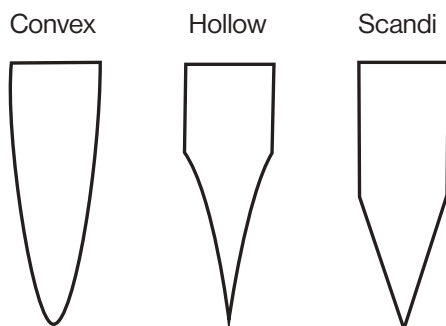

Laminated carbon steel (L)

This steel grade is unique for knives from Morakniv. The core of the blade is made of high carbon steel surrounded by a softer alloyed steel layer. A high hardness, HRC 58-60, can be achieved through hardening, and the result is a knife blade with superior toughness and cutting edge retention. Thereby it reaches maximum sharpness and long life. The blade can also be bent into a predetermined shape, which makes knives with these kind of blades appropriate for wood carving.

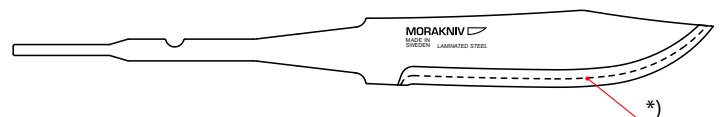

*) The visible line between the hardened and unhardened soft steel.

A: Hardened carbon steel (C ≈ 1%)

B: Soft iron (C < 0,2%)

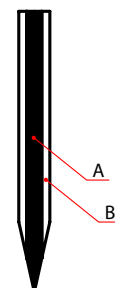



Give you and your knife the best possible conditions

Our knives have been made to last. They should be used over and over again, and for a long time. This way, buying a knife is both economically and environmentally sustainable. But even though our carefully planned production processes lay a strong foundation for the durability of the knife, all knives need a certain amount of maintenance and care.

Take good care of your knife and it will keep even longer. Different knives have differing sensitivities to the impacts from their surroundings and the situations you use them in. The main thing to consider is whether the blade is made of stainless or carbon steel. Read our tips below, and you'll see that the same knife will remain with you in the kitchen, on your fishing trip, or in your tool-box for a long time to come.

Stainless and simple to take care of

Stainless steel is easy to maintain as it has been treated to withstand rust and corrosion. However, if the knife gets dirty it's always good to make it a habit to rinse the blade under running warm water after usage, preferably with a gentle liquid soap. Wipe the knife dry. Remember that even though the blade is stainless, salt marks or such may still appear on the blade that can be hard to remove over time.

Take care of your carbon steel

Unlike stainless steel, all non-stainless steel blades, such as carbon steel blades, will oxidize or be affected by moisture and corrosive environments. So make it a habit to wipe the knife, and preferably oil the blade after usage. For this you can use various liquid oils, such as WD40 and CRC 5-56. All products intended for cleaning weapons are also functional. If you intend to use your knife when cooking we recommend you use paraffin oil, since it's not dangerous to consume.

Be careful when cleaning and wiping the blade so that you don't injure yourself. Some knife users make their own patina to make their blade less sensitive. They stick the blade of the knife in a piece of fruit for a few hours or treat the blade with warm vinegar. There are many good tips and more advice in different online knife groups such as YouTube. Keep in mind that patination is always done at your own risk or initiative.

Washing the knives?

Knives should not be machine-washed. In particular, carbon and laminated steel knives should never be washed in a dishwasher as the aggressive detergent really damages the blade. Stainless steel knives shouldn't be machine washed either. Again, the machine detergent is the culprit that has negative effects on the blade. Also, sharp knives tend to damage the inside of the dishwasher, and let's not forget the risk of personal injury when putting sharp knives in and out of the machine.

Spots and potential corrosion?

If you find that your knife has got spots on the blade and that you're starting to see some corrosion, you've probably got a knife with a carbon steel blade. As mentioned, this makes it sensitive to moisture and water. Be sure to take special care of it: cleaning, drying and oiling your blade after use usually does the trick. Another option is to get a stainless steel blade that doesn't need as much maintenance. Our stainless steel knives are not only more "easy care", they also keep an edge longer as the stainless steel is more wear resistant. Note that cooking in general, salt water, fruit juices, vinegar etc usually make a carbon steel blade start to corrode within seconds.

If your knife has rusted, you can try to polish the blade with a sanding block or cork, such as Schleifix Klingspor or similar, with a fineness grit of 240 or more. However, it's practically impossible to recover the blade's original surface.



C. ANDERSSON
MORA

What does the spine of your knife look like?

Our knives have one of three different spine types, depending on the model and its intended area of use. If you think the spine of your knife seems to be unfinished or just want to learn more about the spine of your knife – keep on reading!

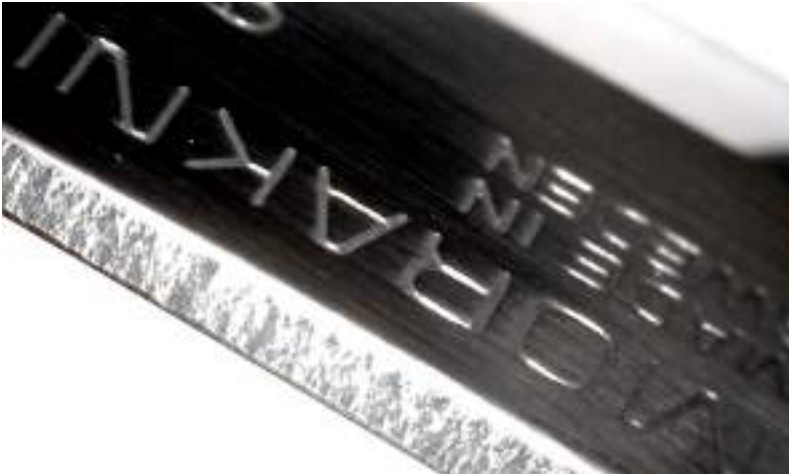

Not grinded, but polished spine

This image shows a polished/buffed 2,0 mm thick blade with no spine grinding. This particular blade can be found on our craft knives, where the sharp, durable edge and steady handle are high priorities, but the spine finish isn't. Knives with this grinding aren't compatible with a fire starter, due to the rounded corners of the spine.



Grinded and polished spine

This image shows a polished/buffed 2,5 mm thick blade with spine grinding. This blade can be found on several of our outdoor knives and this particular image shows a stainless steel Companion model. Knives with this grinding aren't compatible with fire starter, due to the rounded corners of the spine.



Grinded, but not polished spine

This image shows a 3,2 mm thick blade with grinded spine, more specifically that of the Bushcraft model. The blade hasn't been polished/buffed and the spine corners are sharp, which make knives with this grinding excellent for use with a fire starter.



MORAKNIV
MADE IN SWEDEN
CARBON

The Laboratory

In the heart of our factory in Mora, Sweden, we have our very own laboratory and testing facility. Here, our engineers and product developers are running repeated and continuous tests of both existing and future knife models. Every step is a part of our continuous work to assure that the knives that are being delivered to you are of the highest possible quality. To have a lab in our very own factory brings many valuable opportunities. We can take a knife straight from the production line, and in a matter of seconds put it to the test in the laboratory. This of course goes the other way round: as soon as we make an important discovery, or get an interesting test result, we can instantly apply the new knowledge to the production process.

The laboratory facility holds many different kinds of machines and advanced technical solutions, tuned to test and evaluate all the different parts of the knife. How much bending force can a Robust take? For how long does a Chef's knife keep its extreme sharpness? As the results are being compiled and evaluated, we can make all the adjustments and calculations needed to improve our high quality products even further.

The most important aspect of any knife is its sharpness.

Our knives are known and appreciated for their ability to stay sharp for a very long time. A great part of that feature is of course the grinding of the blade. Another great part are the repeated tests and evaluations we run in the lab

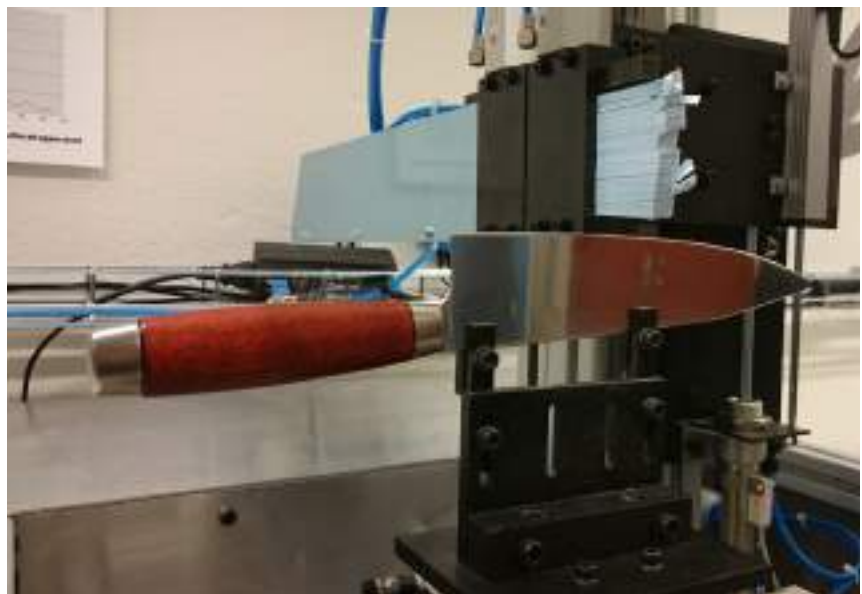

Many of our knives need to be flexible. This mainly applies to our wide range of food processing knives, but all our models need to have strong and reliable blades.

The laboratory allows us to test and evaluate the bending force, so that we can ensure that the way we treat the steel - according to our SGM® (Steel Grade Mora) standard - is as well functioning as ever.





Eco-friendly manufacturing

Traditionally every little piece of material used in the process of making the knives has been taken care of. Nothing could be wasted, mainly for economical reasons. A great example is the recycling of wood left overs from sleigh manufacture in what became the first Morakniv factory way back in the 19th century. These parts became perfect for creating wooden handles for a completely different product: knives.

Today we continue to ensure our material is used efficiently and not just for economic reasons. Ecological, economic and social sustainability are guiding principles for our production. We work to minimise our adverse environmental impact, to make more efficient use of energy and materials, and to create a good working environment.

We continuously improve the way we work, in order to preserve our wonderful environment. This creates both economical sustainability for the company, and ecological sustainability through the prevention of pollution. We also work to eliminate a number of products containing hazardous substances and to prioritize the use of reusable and recyclable materials.

Our ISO 9001:2015 and ISO14001:2015 accreditations reflect the company's commitment to quality and sustainability.



Our accreditations ISO 9001:2015 and ISO14001:2015 reflect the company's commitment to quality and sustainability.





A red dot for quality design

Our range of professional craft knives are rewarded with the prestigious Red Dot for high design quality. The international jury only awards this sought-after seal of quality to projects that set themselves apart significantly from comparable projects thanks to their excellent design.

"These high-quality knives combine a traditional craftsmanship with modern design. The colours indicate the knives' respective purposes" was the jury motivation.

Awarded high quality knives

Morakniv is well known for its products of highest quality. Apart from the appreciation from our customers and users, we have also been awarded several prizes and special distinctions for everything from product design and development to brand strength and graphic profile.

Eldris is a winner

The pocket size knife from Morakniv was awarded the prestigious Scandinavian Outdoor Award at the Outdoor fair in Friedrichshafen. It's compact design and over all-round convenience adds something entirely new to the outdoor world. This was acknowledged by the jury of the Scandinavian Outdoor Award who named Morakniv Eldris the winner in the Hardware category.

Brand and Graphic profile

A cutting edge brand identity combined with a sharp brand strategy have made the knives from Mora, Sweden well known all over the world. To pay tribute to this successful work, Morakniv was given the prestigious award Brand of the Year in 2016.

On the same note our graphic profile won the internationally renowned award Svenska Designpriset. The updated look highlights the fact that our knives are made in Sweden, the strong connection to our origins in Dalecarlia, and the grant as Royal Purveyor, a sign for Swedish quality. And with the elements of the traditional Morakniv, the red handle and the metal blade, there is a focus on the history of the Morakniv brand.



reddot design award



Contact us

Address:

Morakniv AB
Box 407
SE-792 27 Mora, Sweden

Visitors address:

Bjäkenbacken 4
SE-792 95 Mora, Sweden

Telephone:

+46 250-59 50 00

Fax:

+ 46 250-59 50 01

E-mail:

info@morakniv.se
order@morakniv.se
sales@morakniv.se

Our Sales Department

Sales Director | Scandinavia

Pia Frick-Larsson
pia-frick-larsson@morakniv.se

Sales Manager | Europe

Catherine Brochard
catherine.brochard@morakniv.se

Sales Director | Middle East and Africa

Bashar Mustafa
bashar.mustafa@morakniv.se

Sales Director | North and South America

Tobias Eklund
tobias.eklund@morakniv.se

Sales Manager | Asia, Oceania

Stephen Wong
stephen.wong@morakniv.se



Morakniv in media

On our website www.morakniv.se you can find all the information about Morakniv you need. There we present all our products, company and contact information, inspiration, tips & tricks, company history, historical catalogs and much more.

We're also active on various social media channels and you are more than welcome to use our material on your own channels. If you create your own Morakniv content, use #morakniv or @morakniv, so that we can find it.

Product images and PDF catalogs

If you need to download product images you are welcome to visit our Image bank. There you can find images of all our Morakniv and Frosts products as well as environmental images, brand and factory images, and logotypes.

Contact your Sales Director for more information on how to access the Image bank.

Social Media material

Using Social Media to build a buzz around Morakniv products and your company, offers many fantastic possibilities. You reach a wide audience in an easy and efficient way. Take advantage of the social media channels you and your company uses today to spread the word about what you offer.

To make your work easier, and to inspire you to explore the possibilities of social media even further, we have put together a collection of suggested posts and competitions that you can use on your channels. Check the "Launch material" folders in the image bank for suggestions and inspiration.

You can also use our weekly Facebook posts on your own channels. Contact your Sales Director to get access.

Photo Creds

In this catalogue we use, among others, images of the following photographers: Ida Olsson, Håkan Olsén, Anthony Tian, Fredrik Telléus & Andreas Söderlund.



What adventure are you looking for?
#morakniv2000



MORAKNIL ®